

Owner's Manual
for Vehicle



X5 3.0i
X5 4.4i
X5 4.6is

Congratulations, and thank you for choosing a BMW.

Thorough familiarity with your vehicle will provide you with enhanced control and security when you drive it. We therefore have this request:

Please take the time to read this Owner's Manual and familiarize yourself with the information that we have compiled for you before starting off in your new BMW. The manual contains important data and instructions intended to assist you in obtaining maximum satisfaction from your BMW's unique array of advanced technical features. It also contains information on vehicle maintenance designed to enhance operating safety while simultaneously helping you to maintain your BMW's value throughout an extended service life. For additional information refer to the supplemental manuals.

This Owner's Manual should be considered a permanent part of this vehicle. It should stay with the vehicle when sold to provide the next owner with important operating, safety and maintenance information.

We wish you an enjoyable driving experience.

BMW AG

Contents

Notes	About this Owner's Manual	8
	Symbols used	8
	The individual vehicle	8
	Status at time of printing	9
	For your own safety	9
	Symbol on vehicle parts	10
	Service and Warranty	10
Reporting safety defects	10	

Overview	Cockpit	14
	Instrument cluster	15
	Indicator and warning lamps	19
	Steering wheel with multifunction buttons	23
	Warning triangle	24
	First-aid kit	24
	Refueling	24
	Fuel specifications	26
Tire inflation pressures	26	

Controls and features	Locks and security systems:	
	Keys	30
	Central locking system	30
	Opening and closing	
	– via the remote control	31
	Opening and closing	
	– via the door lock	34
	Opening and closing	
	– from the inside	35
	Liftgate	36
	Tailgate	37
	Alarm system	39
	Electric power windows	40
	Sliding/tilt sunroof with glass moonroof	42
	Adjustments:	
	Safe seating position	44
	Seats	44
Mechanical seat	45	
Power seat	46	
Head restraints	47	
Power rear-seat backrest adjustment	48	
Safety belts	49	
Seat, mirror and steering wheel memory	50	
Seat heating	51	
Steering wheel	52	
Steering wheel heating	53	
Mirrors	53	

- Controls and features**
- Passenger safety systems:**
 - Airbags 55
 - Transporting children safely 58
 - Vehicle Memory, Key Memory 61
 - Driving:**
 - Ignition lock 62
 - Starting the engine 62
 - Switching off the engine 63
 - Parking brake 64
 - Manual transmission 64
 - Automatic transmission with Steptronic 65
 - Indicator/Headlamp flasher 68
 - Washer/Wiper system/Rain sensor 68
 - Cruise control 71
 - Everything under control:**
 - Odometer, outside temperature display 73
 - Tachometer 74
 - Energy control 74
 - Temperature gauge 75
 - Fuel gauge 75
 - Coolant temperature gauge 76
 - Service Interval Display 76
 - Check Control 77
 - Computer 80
 - Multi-Information Display MID 81
 - Digital clock in the MID 82
 - Computer in the MID 85
 - Technology for safety and driving convenience:**
 - Park Distance Control PDC 90
 - Dynamic Stability Control DSC 91
 - Hill Descent Control HDC 93
 - Self-leveling suspension 94
 - 2-axle self-leveling suspension 94
 - Tire Pressure Monitor RDC 97
 - Adaptive brake light 98
 - Lamps:**
 - Parking lamps/Low beams 99
 - Instrument lighting 100
 - High beams/Standing lamps 100
 - Fog lamps 100
 - Interior lamps 101
 - Controlling the climate for pleasant driving:**
 - Air conditioner 102
 - Automatic climate control 105
 - Roller sun blinds 111
 - Independent ventilation system 111
 - Cabin convenience:**
 - BMW Universal Transmitter 112
 - Glove compartment 115
 - Storage compartments 116
 - Cellular phone 116
 - Beverage holder 116
 - Glasses compartment 117
 - Ashtray, front 117
 - Ashtray, rear 118
 - Cigarette lighter, rear 118
 - Loading and transporting:**
 - Ski bag 119
 - Cargo area
 - Fold the rear backrests down 120
 - Cargo area cover 121
 - Partition net 122
 - Cover panels in the cargo area 123
 - Power outlets 124
 - Pull-out cargo floor 124
 - Cargo loading 126
 - Roof-mounted luggage rack 127

Contents

Operation, maintenance

Special operating instructions:

- Break-in procedures [130](#)
- Driving your BMW X5 [131](#)
- General driving notes [132](#)
- Antilock Brake System [132](#)
- Brake system [132](#)

Wheels and tires:

- Tire inflation pressures [134](#)
- Tire condition [134](#)
- Tire replacement [135](#)
- Wheel and tire combinations [137](#)
- Winter tires [138](#)
- Snow chains [138](#)

Under the hood:

- Hood [139](#)
- Engine compartment essentials [140](#)
- Washer fluid [141](#)
- Engine oil [141](#)
- Coolant [143](#)
- Brake fluid [144](#)

Care and maintenance:

- The BMW Maintenance System [145](#)

Laws and regulations:

- Technical modifications [146](#)
- California Proposition 65 Warning [146](#)
- OBD interface socket [147](#)

Owner service procedures

Replacement procedures:

- Onboard tool kit [150](#)
- Windshield wiper blades [150](#)
- Lamps and bulbs [151](#)
- Changing a wheel [154](#)
- Battery [160](#)
- Fuses [160](#)

Assistance, giving and receiving:

- Jump-starting [162](#)
- Towing the vehicle [164](#)

Technical data

- Engine specifications 168
- Dimensions 169
- Weights 170
- Capacities 171

Index

- Everything from A to Z 174

About this Owner's Manual

We have made every effort to ensure that you are able to find what you need in this Owner's Manual as quickly as possible. The fastest way to find certain topics is by using the detailed index at the end. If you desire an initial overview of your vehicle, this can be found in the first chapter.

Should you wish to sell your BMW at some time in the future, please remember to hand over the Owner's Manual to the new owner; it is an important part of the vehicle.

If you have any questions, your BMW Sports Activity Vehicle center will be glad to advise you.

Symbols used



Indicates precautions that must be followed precisely in order to avoid the possibility of personal injury and serious damage to the vehicle.



Contains information that will assist you in gaining the optimum benefit from your vehicle and enable you to care more effectively for your vehicle.



Refers to measures that can be taken to help protect the environment.

◀ Marks the end of a specific item of information.

* Indicates special equipment, country-specific equipment and optional extras.



Identifies systems or components, which can be activated or adapted to suit an individual driver's requirements – Vehicle Memory, Key Memory, refer to page [61](#).

Activation and adjustments on some of these systems can be performed at your BMW Sports Activity Vehicle center.

The individual vehicle

On buying your BMW, you have decided in favor of a model with individualized equipment and features. This Owner's Manual describes all models and equipment that BMW offers within the same group.

We hope you will understand that equipment and features are included that you might not have chosen for your vehicle. Any differences can easily be identified, since all optional extras and special equipment are marked with an asterisk *.

If your BMW features equipment which is not described in this Owner's Manual, Supplementary Owner's Manuals are enclosed. We ask you to read these manuals as well.

Status at time of printing

BMW pursues a policy of continuous, ongoing development that is conceived to ensure that our vehicles continue to embody the highest quality and safety standards combined with advanced, state-of-the-art technology. For this reason, it is possible that the features described in this Owner's Manual could differ from those on your vehicle. Nor can errors and omissions be entirely ruled out. You are therefore asked to appreciate that no legal claims can be entertained on the basis of the data, illustrations or descriptions in this manual.

For your own safety

 Use unleaded gasoline only. Fuels containing up to and including 10% ethanol or other oxygenates with up to 2.8% oxygen by weight – that is, 15% MTBE or 3% methanol plus an equivalent amount of co-solvent – will not void the applicable warranties respecting defects in materials or workmanship. Field experience has indicated significant differences in fuel quality – volatility, composition, additives, etc. – among gasolines offered for sale in the United States and Canada. The use of poor-quality fuels may result in driveability, starting and stalling problems especially under certain environmental conditions such as high ambient temperature and high altitude. Should you encounter driveability problems which you suspect could be related to the fuel you are using, we recommend that you respond by switching to a recognized high-quality brand. Failure to comply with these recommendations may result in unscheduled maintenance. Obey pertinent relevant safety rules when you are handling gasoline. ◀



Important safety information!
For your own safety, use genuine parts and accessories approved by BMW.
When you purchase accessories tested and approved by BMW and Original BMW Parts, you simultaneously acquire the assurance that they have been thoroughly tested by BMW to ensure optimum performance when installed on your vehicle.
BMW warrants these parts to be free from defects in material and workmanship.
BMW will not accept any liability for damages resulting from installation of parts and accessories not approved by BMW.
BMW cannot test every product on the market to determine whether it can be used on a BMW safely and without risk to either the vehicle, its operation, or its occupants.
Original BMW Parts, BMW Accessories and other products approved by BMW, together with professional advice on using these items, are available from all BMW Sports Activity Vehicle centers.

Installation and operation of non-BMW approved accessories such as alarms, radios, amplifiers, radar detectors, wheels, suspension components, brake dust shields, telephones – including operation of any portable cellular phone from within the vehicle without using an externally mounted antenna – or transceiver equipment such as CB, walkie-talkie, ham radio or similar accessories, may cause extensive damage to the vehicle, compromise its safety, interfere with the vehicle's electrical system or affect the validity of the BMW Limited Warranty. Contact your BMW Sports Activity Vehicle center for additional information. ◀



Maintenance, replacement, or repair of the emission control devices and systems may be performed by any automotive repair establishment or individual using any certified automotive part. ◀

Symbol on vehicle parts



Indicates that you should consult the relevant section of this Owner's Manual for information on a particular part or assembly.

Service and Warranty

This manual is supplemented by a Service and Warranty Information Booklet for US models or a Warranty and Service Guide Booklet for Canadian models.

We recommend that you read this publication thoroughly.

Your BMW is covered by the following warranties:

- ▷ New Vehicle Limited Warranty
- ▷ Rust Perforation Limited Warranty
- ▷ Federal Emissions System Defect Warranty
- ▷ Federal Emissions Performance Warranty
- ▷ California Emissions Control System Limited Warranty

Detailed information about these warranties is listed in the Service and Warranty Information Booklet for US models or in the Warranty and Service Guide Booklet for Canadian models.

Reporting safety defects

The following only applies to vehicles owned and operated in the US.

If you believe that your vehicle has a defect which could cause a crash or could cause injury or death, you should immediately inform the National Highway Traffic Safety Administration NHTSA in addition to notifying BMW of North America, LLC, P.O. Box 1227, Westwood, New Jersey 07675-1227, Telephone 800-831-1117.

If NHTSA receives similar complaints, it may open an investigation, and if it finds that a safety defect exists in a group of vehicles, it may order a recall and remedy campaign. However, NHTSA cannot become involved in individual problems between you, your dealer, or BMW of North America, LLC.

To contact NHTSA, you may either call the Auto Safety Hotline toll-free at 1-800-424-9393 – or 366-0123 in Washington, D.C. area – or write to: NHTSA, U.S. Department of Transportation, Washington, D.C. 20590. You can also obtain other information about motor vehicle safety from the Hotline.



Overview

Controls and features

Operation, maintenance

Owner service procedures

Technical data

Index



14 Cockpit

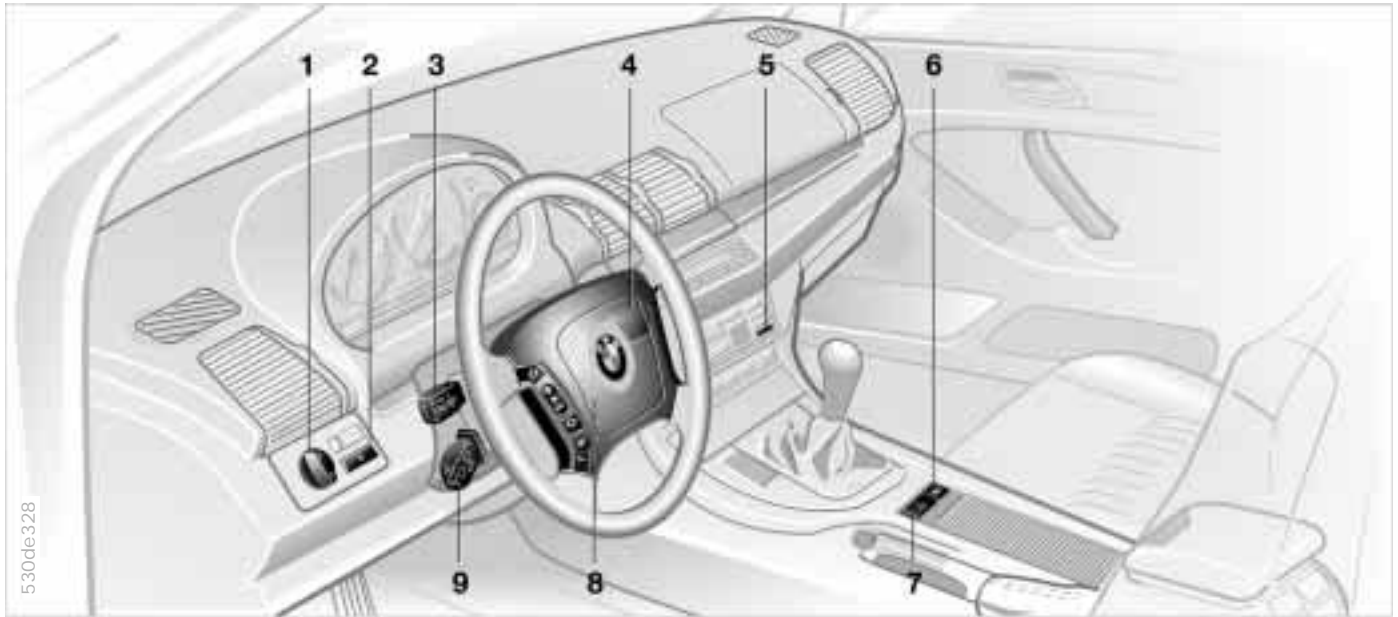

1 Parking lamps/Low beams [99](#)

2 Fog lamps [100](#)

3 ▷ Turn signal indicators [68](#)

▷ Standing lamps [100](#)

▷ High beams [100](#)

▷ Headlamp flasher [68](#)

▷ Computer [80](#)

4 Washer/Wiper system/Rain sensor [68](#)

5 Rear window defroster [103](#), [108](#)

6 Central locking system [30](#)

7 Hazard warning flashers

8 Horn, the entire surface

9 Adjusting steering wheel [52](#)



1 Fuel gauge [75](#)

2 Indicator lamp for turn signal indicators [22](#)

3 Speedometer

4 Indicator and warning lamps [19 to 22](#)

5 Tachometer and Energy Control [74](#)

6 Coolant temperature gauge [76](#)

16 Instrument cluster BMW X5 3.0i, 4.4i



- 7 Indicator and warning lamps [19 to 22](#)
- 8 Reset button for trip odometer [73](#)
- 9 Indicator for Check Control [77](#)
- 10 Odometer and trip odometer [73](#)
- 11 Computer display – operation via the turn signal lever, refer to page [80](#):
 - ▷ Outside temperature
 - ▷ Average fuel consumption
 - ▷ Cruising range
 - ▷ Average speed
- 12 Service Interval Display [76](#)
- 13 Selector lever and program display for automatic transmission* [65](#)
- 14 Indicator and warning lamps [19 to 22](#)



530us226

- | | | |
|--|--|--|
| 1 Fuel gauge 75 | 7 Indicator and warning lamps 19 to 22 | 11 Indicator for Check Control 77 |
| 2 Indicator lamp for turn signal indicators 22 | 8 Reset button for trip odometer 73 | 12 Selector lever and program display for automatic transmission* 65 |
| 3 Speedometer | 9 Service Interval Display 76 | 13 CHECK button 77 |
| 4 Indicator and warning lamps 19 to 22 | 10 Display for
▷ Trip odometer 73
▷ Outside temperature display 73 | 14 Indicator and warning lamps 19 to 22 |
| 5 Tachometer and Energy Control 74 | | |
| 6 Coolant temperature gauge 76 | | |

18 Instrument cluster BMW X5 4.6is



- 1 Fuel gauge [75](#)
- 2 Indicator lamp for turn signal indicators [22](#)
- 3 Speedometer
- 4 Indicator and warning lamps [19 to 22](#)
- 5 Tachometer and Energy Control [74](#)
- 6 Coolant temperature gauge [76](#)
- 7 Indicator and warning lamps [19 to 22](#)
- 8 Reset button for trip odometer [73](#)
- 9 Service Interval Display [76](#)
- 10 Display for
 - ▷ Trip odometer [73](#)
 - ▷ Outside temperature display [73](#)
- 11 Indicator for Check Control [77](#)
- 12 Selector lever and program display for automatic transmission* [65](#)
- 13 CHECK button [77](#)
- 14 Indicator and warning lamps [19 to 22](#)

Indicator and warning lamps

Technology that monitors itself

Indicator and warning lamps that are identified by ● are tested for proper functioning whenever the ignition key is turned. They each light up once for different periods of time.

If a fault should occur in one of these systems, the corresponding lamp does not go out after the engine is started or it lights up while the vehicle is moving. You will see how to react to this in the following section.

Red: stop immediately



Battery charge current ●
The battery is no longer being charged. There is a malfunction of the alternator drive belt or in the charging circuit of the alternator. Please contact the nearest BMW Sports Activity Vehicle center.



▲ If the drive belt is defective, do not continue driving. The engine could be damaged due to overheating. If the drive belt is defective, increased steering effort is also required. ◀



Engine oil pressure ●
Stop the vehicle immediately and switch off the engine. Check the engine oil level; top off as required. If the oil level is correct: please contact the nearest BMW Sports Activity Vehicle center.



▲ Do not continue driving. The engine could be damaged because of inadequate lubrication. ◀



Parking brake* / Brake hydraulic system ●
Comes on when you engage the parking brake.
For additional information: refer to page 64.

Comes on although the parking brake is released: have the brake fluid level checked. Before continuing your journey, be sure to read the notes on pages 132 and 144.

Also comes on in the Check Control with the message CHECK BRAKE LININGS.



Parking brake warning lamp* / Brake hydraulic system warning lamp for Canadian models.



Tire Pressure Monitor RDC* ●
In addition, an acoustic signal is sounded: a flat tire has occurred. Reduce vehicle speed immediately and stop the vehicle. Avoid hard brake applications. As you steer the vehicle, use caution and avoid overcorrecting.
For additional information: refer to page 96.

20 Indicator and warning lamps

Red or yellow: continue to drive; drive cautiously



If the brake warning lamp comes on red together with the yellow warning lamps for ABS and DSC:



Continue to drive; drive cautiously and defensively and avoid full brake applications.



Have the system checked by the nearest BMW Sports Activity Vehicle center.

For additional information: refer to pages [91](#) and [132](#).

If all three warning lamps come on yellow:

Continue to drive; drive cautiously and defensively and avoid full brake applications.

Have the system checked by your BMW Sports Activity Vehicle center as soon as possible.



Warning lamps for Canadian models.



Red: an important reminder



Parking brake*
Comes on when the parking brake is engaged.

For additional information: refer to page [64](#).



Parking brake* warning lamp for Canadian models.



Please fasten safety belts ●
Lights up either for a few seconds or, depending on model, until the belt is engaged.

Depending on model, together with an acoustic signal* or a message* in the Check Control.

For additional information on safety belts: refer to page [49](#).



Airbags ●
Please have the system inspected by your BMW Sports

Activity Vehicle center.

For additional information: refer to page [55](#).

Yellow: check as soon as possible



Antilock Brake System ABS ●
ABS has been deactivated in response to system malfunction.

Conventional braking performance remains available with no loss of efficiency. Please have the system inspected by your BMW Sports Activity Vehicle center.

For additional information: refer to page [132](#).



ABS warning lamp for Canadian models.



Engine oil level

Comes on while driving:

The oil level is at the absolute minimum; refill as soon as possible. Do not drive more than approx. 30 miles/ 50 km until you do.

For additional information: refer to page [141](#).



Engine oil level

Comes on after the engine has been switched off: add engine oil at your earliest opportunity, e.g. when you stop to refuel.

For additional information: refer to page [141](#).

Indicator and warning lamps



Automatic transmission*

Because of a malfunction, the automatic transmission shifts only in the emergency program. Please consult the nearest BMW Sports Activity Vehicle center.

For additional information: refer to page [67](#).



Brake pads* ●

Have the brake pads checked. For additional information: refer to page [132](#).



Self-leveling suspension* ●

Self-leveling suspension is inactive. Please consult the nearest BMW Sports Activity Vehicle center. For additional information: refer to page [94](#).



Dynamic Brake Control DBC ●

Fault in the DBC system. Conventional braking performance remains available with no loss of efficiency.

Please have the system checked and repaired by your BMW Sports Activity Vehicle center.

For additional information: refer to page [92](#).



Dynamic Brake Control DBC warning lamp for Canadian models.



Dynamic Stability Control

DSC ●

Indicator lamp flashes:

The system is active and governs drive and braking force.

The warning lamp comes on and stays on while driving:

DSC has been switched off with the button. If, after repeatedly pressing the DSC button, the warning lamp still does not go off, then that means that the DSC, HDC and the vehicle's road-holding ability are defective.

Please have the system checked by the nearest BMW Sports Activity Vehicle center.

For additional information: refer to pages [91](#) and [93](#).



Engine electronics*

There is a fault in the engine's electronic control system. You can continue to drive with reduced engine output or engine speed. Please have the system checked by your BMW Sports Activity Vehicle center.



Tire Pressure Monitor RDC* ●

Check tire inflation pressures, refer to pages [26](#), [97](#).



Service Engine Soon ●

If the indicator lamp comes on either continuously or intermittently, this indicates a fault in the emissions-related electronic systems. Although the vehicle remains operational, you should have the systems checked by your BMW Sports Activity Vehicle center at the earliest possible opportunity.

For additional information: refer to page [147](#).



Service Engine Soon warning lamp for Canadian models.



Check Filler Cap* ●

This indicator lamp comes on when the fuel filler cap is loose or missing.

Close the filler cap tightly: refer to page [25](#).

22 Indicator and warning lamps

Green: for your information



Turn signal indicators

Flashes when the turn signal indicators are operated. Rapid flashing indicates a system malfunction.

For additional information: refer to page [68](#).



Cruise control*

Comes on when the cruise control is activated: available for operation via the steering wheel with multifunction buttons.

For additional information: refer to page [71](#).



Fog lamps

Lights up whenever you switch on the fog lamps.

For additional information: refer to page [100](#).

Blue: for your information



High beams

Lights up when the high beams are on or the headlamp flasher is actuated.

For additional information: refer to pages [68](#) and [100](#).

Steering wheel with multifunction buttons*

The buttons integrated in the steering wheel are provided so that you can operate a number of accessories quickly and without being distracted from traffic conditions. You may operate:

- ▷ selected control functions for the radio along with CD and cassette player
- ▷ the recirculated-air mode of the air conditioner* or the steering-wheel heating*
- ▷ the cruise control
- ▷ selected phone functions and
- ▷ the voice entry

 In order to operate a system, the corresponding system must be switched on. ◀



Press briefly:
Accept incoming call, start dialing, terminate call.
Extended pressure:
Activate/deactivate voice entry.



Switch between phone and radio, cassette and CD.



Forward:

- ▷ Radio
Press briefly: next stored station
Extended pressure: station search function
- ▷ CD
Press briefly: jump to next track
Extended pressure: fast forward in track
- ▷ Cassette
Press briefly: stop track scan or fast forward
Extended pressure: fast forward
- ▷ Phone
Scan personal phone book.



Reverse: functions as for fast forward.



Volume



Cruise control: calling up.



Cruise control: store and accelerate + or decelerate and store -.



Cruise control: activate/interrupt/deactivate.



Recirculated-air mode and automatic recirculated-air control AUC or steering wheel heating: switch on/off.

24 Warning triangle*

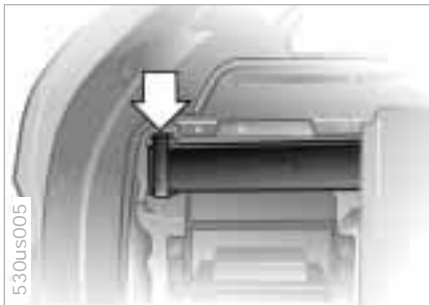

1. Open the cover on the left in the cargo area: lift the handle on the cover
2. Pull the tab of the retaining strap, refer to arrow, and remove the hazard warning triangle from the support bracket
3. To install: slide the hazard warning triangle into the support bracket and press on the retaining strap.

 Always observe all legal regulations requiring a warning triangle to be carried in the vehicle. ◀

First-aid kit*



The first-aid kit is located under the front passenger's seat.

To open: pull the handle and fold the cover down.

To close: fold the cover up.

 Some of the articles in the first-aid kit may be used within a limited time only. For this reason, check the expiration dates of each of the items regularly, and replace any whose expiration dates have passed. You can acquire replacements in any drugstore or pharmacy. Always observe all legal regulations requiring a first-aid kit to be carried in the vehicle. ◀

Refueling

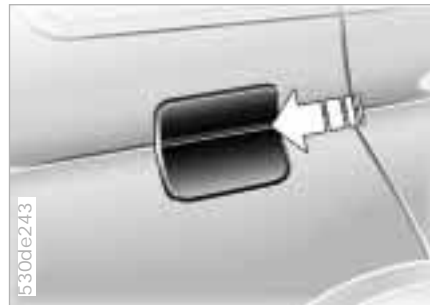

Fuel filler door

 Before filling the tank, switch off the engine. If you do not, fuel cannot be filled into the tank and the Service Engine Soon lamp may come on. ◀

To open the fuel filler door, press on the front edge.

In the event of an electrical malfunction, you can also open the fuel filler door manually:

1. Open the cover on the right in the cargo area: lift the handle on the cover
2. Pull the knob with the fuel pump symbol.

Refueling

⚠ When handling fuels, comply with all of the applicable safety precautions and regulations pertaining to fuels. Never carry spare fuel containers in your vehicle. Whether empty or full, these containers can leak, cause an explosion, or lead to fire in the event of a collision. ◀



Simple and environmentally friendly

⚠ Open the filler cap carefully to prevent fuel from spraying out. Fuel spray may cause injury. Do not top off. Topping off may cause fuel spillage. ◀

Keep the filler cap in the bracket attached to the fuel filler door.

When refueling, insert the filler nozzle completely into the filler pipe. Pulling the nozzle out of the pipe during refueling

- ▷ results in premature pump shutoff
- ▷ and will reduce the effect of the vapor recovery system on the pump.

As long as the filler nozzle is used properly, the fuel tank is full whenever the nozzle shuts off the first time.

⚠ Close the filler cap carefully after refueling until a click is heard. While closing, be sure not to squeeze the strap which is fastened to the cap. A loose or missing cap will activate the message – CHECK FILLER CAP – in the Check Control* or the Check Filler Cap lamp*. ◀

Tank capacity:
 approx. 24.6 gal./approx. 93 liters,
 with a reserve capacity of
 6-cylinder engine: approx. 2.0 gal./
 approx. 8 liters
 8-cylinder engine: approx. 2.5 gal./
 approx. 10 liters.

⚠ Do not drive until the tank is completely empty, as otherwise engine functions are not ensured and damage can occur. ◀

26 Fuel specifications

The engine uses lead-free gasoline only.

Required fuel:

▷ Premium Unleaded Gasoline,
min. 91 AKI.

AKI = Anti Knock Index

 Do not use leaded fuels. The use of leaded fuels will cause permanent damage to the system's oxygen sensor and the catalytic converter. ◀

Tire inflation pressures



Check tire pressures

All pressure specifications are indicated in psi/kilopascal for tires at ambient temperature, refer also to the table on the next page.

Vehicles with Tire Pressure Monitor RDC:

After correcting the inflation pressures, reactivate the system, refer to page [97](#).

 Check tire inflation pressures regularly – at least every two weeks and before beginning a longer trip. Incorrect tire pressure can otherwise lead to poor handling, tire damage and accidents.



Check the tire inflation pressure of the spare tire. Inflate the spare tire to the highest inflation pressure of any tire on your vehicle. ◀

Comply with tire approval specifications

The inflation pressures in the table apply to tire sizes and tires from BMW-approved manufacturers. Your BMW Sports Activity Vehicle center is familiar with these pressures. A different inflation pressure may be required for tire makes not approved by BMW.

Your vehicle is equipped with tires that not only meet US standards, but also European standards. We recommend the exclusive use of BMW-approved tires.

Tire inflation pressures

BMW	Tires	All pressure specifications in the table are indicated in psi/kilopascal with cold tires, cold = ambient temperature			
					
X5	All sizes	32/220	32/220	32/220	39/270



Overview

Controls and features

Operation, maintenance

Owner service procedures

Technical data

Index

Overview

Controls

Maintenance

Repairs

Data

Index



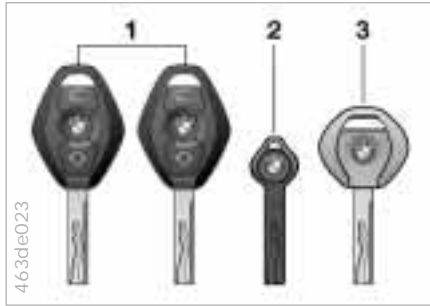

The key set

- 1 The master keys with remote control determine the functions of the Key Memory, refer to page 61. You can mark individual keys for subsequent identification by applying the colored decals that you received when accepting delivery of your vehicle

 There is an extended-life battery in every master key which is charged automatically in the ignition lock as you drive. For this reason, if you have a master key that is otherwise not used, use that key approx. once every year while driving for an extended period. This will charge the battery, refer also to page 31. ◀

- 2 Spare master key for storage in a safe place, such as in your wallet. This key is not intended for continuous use
- 3 Door and ignition key
The lock for the glove compartment cannot be operated with this key. This is recommended for valet parking, for instance.

Central locking system

The concept

The central locking system is ready for operation as soon as you close the front doors. The system engages or releases the locks on the

- ▷ doors
- ▷ liftgate/tailgate
- ▷ fuel filler door.

The central locking system can be operated

- ▷ from outside via the remote control as well as via the driver's door lock
- ▷ from inside via the button for the central locking system.

If the system is locked from inside, the fuel filler door remains unlocked, refer to page 35.

When the system is actuated from outside of the vehicle, the anti-theft system is actuated simultaneously. This prevents the doors from being unlocked via safety lock buttons or door handles. The alarm system is also armed or disarmed.

In the event of an accident, the central locking system unlocks automatically, but only those doors which were not locked separately with the safety lock buttons, refer to page 35. In addition, the hazard warning flashers and interior lamps come on.

Opening and closing – via the remote control

The concept

The remote control makes opening and locking the doors of your vehicle very convenient. Furthermore it provides three additional functions that can only be executed via the remote control:

- ▷ Switch on the interior lamps, refer to page 32.
With this function, you can also search for your vehicle – when parked in an underground garage, for instance
- ▷ Open the liftgate, refer to page 32.
The liftgate will open slightly, regardless of whether it was previously locked or unlocked
- ▷ Panic mode, refer to page 32.
In case of danger, you can trigger an alarm.

Whenever you unlock or lock the vehicle, you simultaneously deactivate/activate the anti-theft system, disarm/arm the alarm system and switch the interior lamps on/off.

 You can have an acknowledgment signal set to confirm that the vehicle is correctly locked. ◀



Since passengers or animals remaining in the vehicle might be able to lock the doors from the inside, take the vehicle's keys with you so that the vehicle can be opened again from the outside at any time. ◀



If it is no longer possible to lock the vehicle via the remote control, the battery is discharged. Use this key while driving for an extended period in order to charge the battery. To prevent unauthorized use of the remote control, surrender only the door and ignition key or the spare key when leaving the vehicle for valet parking, for example, refer to page 30.
In the event of a system malfunction, please contact your BMW Sports Activity Vehicle center. You can also obtain replacement keys there. ◀



- 1 Unlock and convenience opening
- 2 Lock and secure, switching on interior lamps, switching off tilt alarm sensor and interior motion sensor
- 3 Open the liftgate, panic mode

32 Opening and closing – via the remote control

To unlock



Press button.

Press the button once to unlock the driver's door and the fuel filler door only; press a second time to unlock all remaining doors as well as the tailgate/liftgate.

Convenience opening mode



Press and hold button. The power windows and sliding/tilt sunroof are opened.

To lock and secure



Press button.

To switch on the interior lamps



After locking the vehicle, press button again.

To switch off the tilt alarm sensor and interior motion sensor



Press button a second time immediately after locking.

For additional information: refer to page [40](#).

To open the liftgate



Press button.

The luggage compartment lid/liftgate will open slightly, regardless of whether it was previously locked or unlocked.



Before and after a trip, be sure that the tailgate/liftgate was not opened unintentionally. ◀

Panic mode



By pressing and holding the button for more than two seconds, you can trigger an alarm via the alarm system if there is an impending danger (the alarm system must be armed).

To switch off the alarm



Press button.

Opening and closing – via the remote control

System interference

The remote control system may be affected by other units or equipment operating in the immediate vicinity of your vehicle.

If this should occur, you can unlock and lock the vehicle via the door lock with a master key.

For US owners only

The transmitter and receiver units comply with part 15 of the FCC – Federal Communication Commission – regulations. Operation is governed by the following:

FCC ID: LX8EWS
LX8FZVS
LX8FZVE

Compliance statement:

This device complies with part 15 of the FCC Rules. Operation is subject to the following two conditions:

- ▷ This device may not cause harmful interference, and
- ▷ this device must accept any interference received, including interference that may cause undesired operation.

 Any unauthorized modifications to these devices could void the user's authority to operate this equipment. ◀

34 Opening and closing – via the door lock

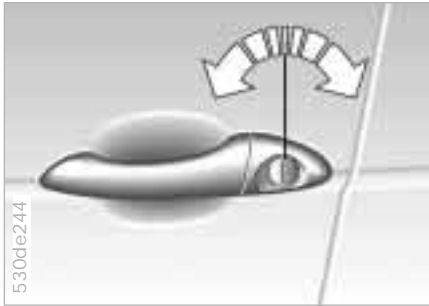

One turn of the key in the driver's door lock unlocks the driver's door only. Turning the key a second time unlocks all of the remaining doors, the liftgate/tailgate and the fuel filler door.



You can have an acknowledgment signal set to confirm that the vehicle is correctly locked. ◀

Convenience operation

You can also operate the windows and sliding/tilt sunroof via the door lock.

- ▷ To open: with the door closed, turn the key to the Unlock position and hold it
- ▷ To close: with the door closed, turn the key to the Lock position and hold it.



Watch during the closing process to be sure that no one is inadvertently injured. Releasing the key stops the operation. ◀

Manual operation

In the event of an electrical malfunction, turn the key to the extreme left or right to unlock/lock the door.

Opening and closing – from the inside



You can operate the central locking system with this button when the driver's door is closed. The doors and liftgate are unlocked or locked only. However, the anti-theft system is not activated. Also, the fuel filler door remains unlocked to allow refueling.



The central locking system can be locked automatically as soon as you begin to drive if you desire. You may also have this function programmed into individual keys. ◀



If only the driver's door was unlocked from the outside and you press the button

- ▷ all other doors, the tailgate/liftgate and the fuel filler door will be unlocked when the driver's door is opened
- ▷ the driver's door will be locked again when it is closed. ◀

To unlock and open the doors

- ▷ Either unlock the doors together with the button for the central locking system and then pull the door handle above the armrest
- ▷ pull the release handle for each door twice: the first pull unlocks the door, and the second one opens it.

To engage the locks

- ▷ Use the central locking button to lock all of the doors simultaneously, or
- ▷ press down the individual safety lock buttons. The fuel filler door remains unlocked. As an added design feature to prevent the driver from being inadvertently locked out of the vehicle, the driver's safety lock button will not engage as long as the door is open.



When the vehicle is moving, do not lock the doors with the safety lock buttons. Doors locked in this manner would not unlock automatically in the event of an accident. Since passengers or animals remaining in the vehicle might be able to lock the doors from the inside, take the vehicle's keys with you so that the vehicle can be opened again from the outside at any time. ◀

36 Liftgate



To open from the outside

Press the button, refer to arrow:
The liftgate opens slightly.

The cargo area is illuminated whenever the liftgate is opened, refer also to page [101](#).



When the liftgate is opened, the clearance from the ground to the upper edge is more than 6.6 ft/2 m. Please keep this in mind when opening the liftgate (in a garage, for example). ◀



Opening from inside the vehicle

Press this button to open the liftgate when the vehicle is stationary.



If pointed or sharp-edged objects could strike the rear window while driving, be sure to provide protection around all edges. If you do not do this, the heating conductors of the rear window could be damaged. ◀

For information on the cargo area cover and on other details in the cargo area, refer to Cargo area, beginning on page [120](#).



Manual release

In the event of an electrical malfunction, you can release the liftgate manually:

1. Remove the plastic plug from inside the cargo area and pull toward the interior, refer to arrow. The liftgate will be released
2. Reinstall the plug.

Liftgate

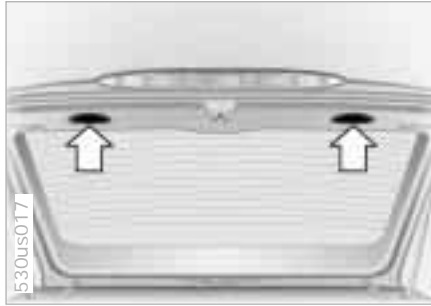

To close

You can pull the liftgate down by placing both hands in the handle recesses, refer to arrows.

 To avoid injuries, be sure that the travel path of the liftgate is clear when it is closed, as with all closing procedures. ◀

-  Operate the vehicle only when both gates are completely closed. Otherwise, exhaust fumes could penetrate the interior of the vehicle. Should it be absolutely necessary to operate the vehicle with an open gate:
- ▷ Close all windows. Shut the sliding/tilt sunroof
 - ▷ Increase the air supply for the air conditioner or automatic climate control to a high level, refer to page [103](#) or [107](#). ◀

Tailgate

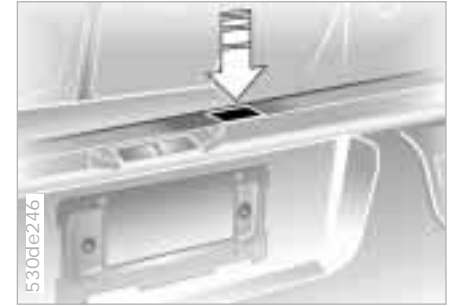

To open

Press the button:
You can fold the tailgate down.

 When opened, the tailgate can accept loads of up to 440 lbs/ 200 kg. When the vehicle is parked, you may utilize the tailgate as a seat or as a loading platform for luggage or recreation gear, for example. ◀

38 Tailgate

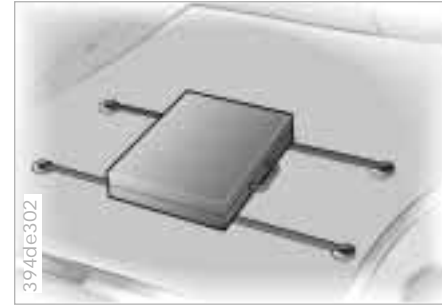
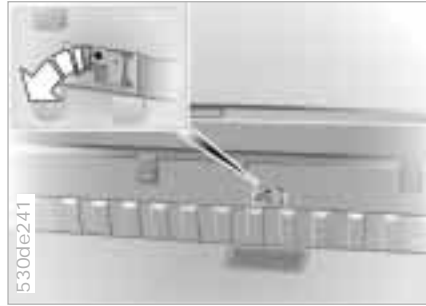
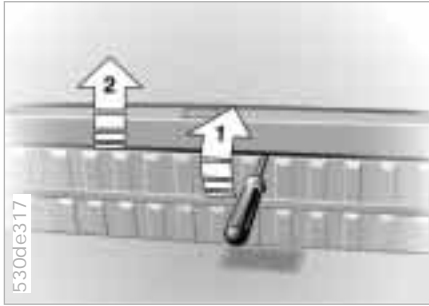

Manual release

In the event of an electrical malfunction, you can release the tailgate manually:

1. Unfasten the trim panel clip with the vehicle key or with a screwdriver, refer to arrow 1, and remove it toward the top, refer to arrow 2

2. Using the same tool, press the latch in the direction of the arrow; the tailgate is released
3. Reinstall the trim panel.

Luggage straps

Use the retaining straps on the cargo area floor to secure smaller items of luggage.

Movement is reduced when objects are placed on the straps.

The lashing eyes located at the corners of the cargo area provide you with a convenient means of attaching luggage nets* or flexible straps for securing luggage.

Refer also to Stowing cargo on page [126](#).

Alarm system

The concept

The vehicle alarm system responds:

- ▷ When a door, the hood, or the liftgate is opened
- ▷ To movement inside the vehicle – interior motion sensor
- ▷ To variations in the vehicle tilt angle such as occur during attempts to steal the wheels or tow the vehicle
- ▷ To interruption of battery voltage.

The system responds to unauthorized vehicle entry and attempted theft by simultaneously activating the following:

- ▷ Sounding an acoustical alarm for 30 seconds
- ▷ The hazard warning flashers are activated for approx. five minutes
- ▷ The high beams flash on and off in the same rhythm.

To arm and disarm the alarm system

When the vehicle is locked or unlocked with the key or the remote control, the alarm system is also simultaneously armed or disarmed.



You can have different acknowledgment signals set to confirm system arming and disarming. ◀



You can still open the liftgate after the system has been armed by pressing the button of the remote control, refer to page 32. When you close the liftgate, it is secured again.



Indicator lamp displays

- ▷ The indicator lamp below the interior rearview mirror flashes continuously: the system is armed
- ▷ The indicator lamp flashes during arming: the door(s), the hood or liftgate are not completely closed. Even if you do not close the alerted area, the system begins to monitor the remaining areas, and the indicator lamp flashes continuously after 10 seconds. However, the interior motion sensor is not activated
- ▷ If the indicator lamp goes out when the system is disarmed: no manipulation or attempted intrusions have been detected in the period since the system was armed

40 Alarm system

- ▷ If the indicator lamp flashes for 10 seconds when the system is disarmed: an attempted entry has been detected in the period since the system was armed.

Following triggering of an alarm, the indicator lamp will flash continuously.

Avoiding unintentional alarms

The tilt alarm sensor and interior motion sensor may be switched off at the same time. To prevent an unintentional alarm from being triggered, in garages with elevator ramps, for instance, or when the vehicle is transported by trailer or train:



Lock the vehicle twice, i. e. arm the system. Press button of the remote control twice in succession or actuate the locks twice with the key.

The indicator lamp lights up briefly and then flashes continuously. The tilt alarm sensor and the interior motion sensor are deactivated as long as the system is armed.

Interior motion sensor

In order for the interior motion sensor to function properly, the windows and sliding/tilt sunroof must be completely closed.

However, be sure to switch off the interior motion sensor – refer to the previous column – when you

- ▷ leave children or animals in the vehicle
- ▷ intend to leave the windows or sliding/tilt sunroof open.

Electric power windows



Open and close windows

From ignition key position 1:

- ▷ Press the switch up to the pressure point:
The window continues to move as long as you continue to hold the switch
- ▷ Press the switch beyond the pressure point:
The window moves downward automatically. Touch the switch again to stop the opening movement.

You can close the windows in the same manner by pulling the switch.

Electric power windows

After the ignition has been switched off:

- ▷ You can still operate the windows as long as neither of the front doors has been opened. To open the windows, press the switch beyond the pressure point.

 Remove the key from the ignition lock and close the doors when you leave the vehicle so that children cannot operate the power windows and possibly injure themselves. ◀

For the convenience mode via the remote control or the door lock, refer to pages [32](#) and [34](#).

Safety feature

A contact strip is integrated into the inner side of each of the upper window frame sections. If pressure is exerted against this contact strip while a window is being raised, the system will respond by stopping the window and then retracting it a small distance.

 Despite this safety feature, be extremely careful that the closing path of the window is not obstructed whenever it is closed. Otherwise, an object might not touch the contact strip in some situations, with very thin objects, for instance.

You can override this safety feature by pulling the switch beyond the pressure point and holding it.

Because the power windows are sealed at high pressure to prevent wind noise when closed, a powerful motor is required for efficient closing. When closing the windows, always ensure that they are not obstructed in any way. Unsupervised use of these systems can result in serious personal injury.

Remove the ignition key to deactivate the electric power windows whenever you leave the vehicle. Never leave the keys in the vehicle with unsupervised children. Never place anything that could obstruct the driver's vision on or next to the windows. ◀



Safety switch

With the safety switch, you can prevent the rear windows from being opened or closed via the switches in the rear passenger area, by children, for example. You can also prevent adjustments of the power rear-seat backrests from the rear passenger area, refer to page [48](#).

 Press the safety switch whenever children are riding in the rear of the vehicle. Careless use of the power windows can lead to injury. ◀

42 Sliding/tilt sunroof with glass moonroof*

 To prevent injuries, exercise care when closing the sliding/tilt sunroof and keep it in your field of vision until it is shut.

Before leaving the vehicle, switch off the electric sunroof mechanism by removing the ignition key. Do not leave children unattended in the vehicle with access to vehicle keys. Use of the key can result in starting of the engine and operation of vehicle systems such as the power sunroof, etc. Unsupervised use of these systems can result in serious personal injury. ◀



Lifting – Opening – Closing

With the ignition key in position 1 or higher, press the switch or slide it in the desired direction until you feel resistance.

The headliner slides back somewhat when you raise the sunroof. When the sunroof is opened the headliner retracts with it. It remains open, and it is possible to slide it back and forth as long as the sunroof is not completely open.

 The headliner insert cannot be closed with the sliding/tilt sunroof in its raised position. ◀

After the ignition has been switched off, you can still operate the sliding/tilt sunroof as long as neither of the front doors has been opened.

For the convenience mode via the remote control or the door lock, refer to pages 32 and 34.

Automatic* opening and closing

Press the switch briefly past the pressure point and then release it.

Other automatic operations are:

▷ With the sunroof open, press the switch briefly toward Lift: the sunroof automatically extends to its fully raised position.

Pressing the switch again briefly stops the motion.

▷ With the sunroof raised, hold the switch toward Open until the roof has reached the desired position.

Safety feature

If the sliding/tilt sunroof encounters resistance when it is

- ▷ closing from the raised position
- ▷ closing at a point roughly past the middle of its travel

the closing cycle is interrupted and the sliding/tilt sunroof will open again slightly.



Despite this safety feature, be extremely careful that the closing path of the sunroof is not obstructed whenever it is closed. Otherwise, triggering the closing-force limitation may not be ensured in some situations, with very thin objects, for instance. You can disable this safety feature by pressing the switch beyond the pressure point and holding it. ◀



Power loss

When the battery is disconnected, for instance, the sunroof may only lift. To reinitialize the mechanism:

1. Raise the sliding/tilt sunroof fully
2. Press and hold the switch for approx. twenty seconds.

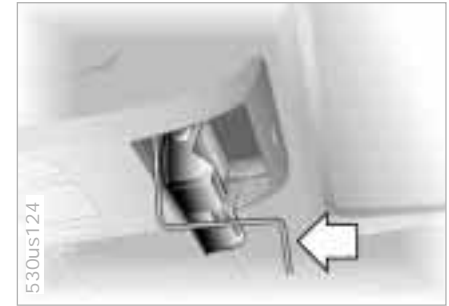

Manual operation

In the event of an electrical malfunction, you can operate the sliding/tilt sunroof manually:

1. Open the glasses compartment, refer to page 117
2. Insert the Allen wrench from the vehicle tool kit, refer to page 150, in the opening provided and turn the sliding/tilt sunroof in the desired direction.

44 Safe seating position

The condition for relaxed, fatigue-free driving is a seating position adjusted to your needs. Together with the safety belts and the airbags, the seating position is very important for the passive safety of the occupants in the case of an accident. Therefore, observe the following instructions, as otherwise the protective function of the safety systems may be impaired.

For additional information on transporting children safely, refer to page [58](#).

Sitting safely with airbags

 Maintain a distance to the airbags. Always hold the steering wheel by the rim with the hands at the 9 and 3-o'clock positions to keep any chance of injury to hands or arms to an absolute minimum, should the airbag be deployed. No one and nothing is to come between the airbags and the seat occupant. Do not use the cover of the front airbag on the front passenger side as a storage area for objects, or as a rest for feet or legs. ◀

For the location of the airbags and additional information, refer to page [55](#).

Sitting safely with safety belts

 Never allow more than one person to wear a single safety belt. Never allow infants or small children to ride in a passenger's lap. Avoid twisting the belt while routing it firmly across the pelvis and shoulder, wear it as snugly against your body as possible. Do not allow the belt to rest against hard or fragile objects in your pockets. Never route the belt across your neck, do not run it across sharp edges and ensure that the belt does not become caught or jammed. Avoid wearing bulky clothing and pull on the lap belt periodically to retension it over your shoulders. In the event of a frontal impact, a loose lap belt could slide over your hips, leading to abdominal injury. In addition, the safety belt's restraint effectiveness is reduced if the belt is worn loosely. Expectant mothers should always wear their safety belts, taking care to position the lap belt against the lower hips, where it will not exert pressure against the abdominal area. ◀

For instructions on operating the safety belts, refer to page [49](#).

Seats

Observe the following before adjusting

 Never try to adjust your seat while operating the vehicle. The seat could respond with unexpected movement, and the ensuing loss of vehicle control could lead to an accident. Never ride with the backrest reclined to an extreme horizontal angle – especially important for front passengers to remember.

If you do so there is a risk that you will slide under the safety belt in an accident, thus reducing the protection provided by the safety belt. ◀

Seat adjustment

- ▷ Mechanical seat adjustment, refer to page [45](#)
- ▷ Power seat adjustment, refer to page [46](#)
- ▷ Head restraints, refer to page [47](#)
- ▷ Power rear-seat backrest adjustment, refer to page [48](#)



Seat adjustment

- 1 Backward/forward adjustment
Pull the lever and slide the seat to the desired position.
After you release the lever, move the seat forward or backward slightly so that it engages fully
- 2 Cushion height
Pull the lever and apply weight to or remove weight from the seat as required



- 3 Backrest angle
Pull the lever and apply weight to or remove weight from the backrest as required.

 Comply with the adjustment instructions on page 44. Failure to do so could result in diminished personal safety. ◀

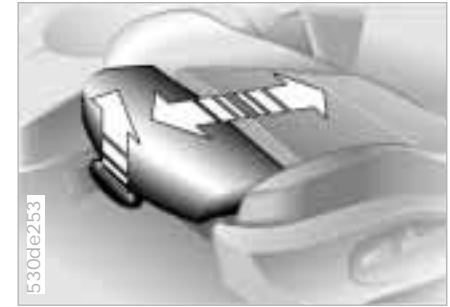

Adjusting the BMW sports seat*

You can adjust the thigh support additionally:
Pull the lever and adjust the position of the thigh support for your personal comfort.

46 Power seat*



Seat adjustment

- 1 Tilt angle – driver's seat only
- 2 Backward/forward adjustment
- 3 Cushion height
- 4 Backrest angle

Adjust the head restraint manually, refer to page 47.

 Comply with the adjustment instructions on page 44. Failure to do so could result in diminished personal safety. ◀



Adjusting the BMW comfort seat*

This seat allows you to make additional adjustments for

- 1 Lumbar support
- 2 Shoulder support
- 3 Head restraint height

Lumbar support:

You can adjust the backrest's contour for additional support in the curvature of your spine's lumbar region.

The upper hips and spinal column receive supplementary support to help you maintain a relaxed, upright seating position.

- ▷ Press the front or rear of the switch: Increase or decrease curvature
- ▷ Press the upper or lower end of the switch: Increase the upper or lower curvature.



Shoulder support:

Move the switch in the direction of the arrow to adjust the tilt angle of the shoulder support.

You can use the adjustable upper backrest for supplementary support in the shoulder region. This provides a relaxed seating position and helps relieve stress on the shoulder muscles.

To obtain the optimal shoulder support position, we recommend:

Driver and front passenger:

1. Adjust the upper backrest section to its extreme rear position
2. Adjust for the optimal sitting position as described on page [44](#)
3. Bring the upper backrest section further forward until your shoulders are well supported.

Front passenger's seat adjusted for relaxed traveling:

1. Adjust the upper backrest section to its extreme rear position
2. Tilt the backrest down to a slightly more horizontal angle
3. Bring the upper backrest section forward until your shoulders are well supported.



Make corrections in the forward/backward adjustment of the seat to ensure that the safety belt still fits firmly against your body. If you do not do this, the protection provided by the safety belt may be reduced. ◀

Head restraint height:

Move the switch in the desired direction.

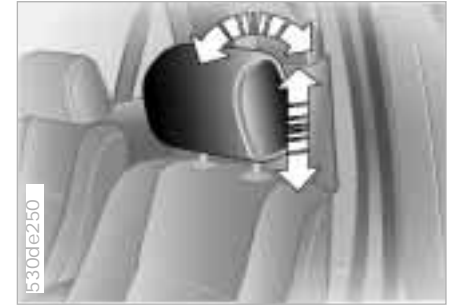

Adjustments

To adjust the angle of the front head restraints, tilt the head restraint to the desired angle.

To adjust the height of the front or rear head restraints, pull the head restraint up or push it down.

Power height adjustment, refer to page [46](#).



Adjust the head restraint so that its center is approximately level with your ears, otherwise the risk of spinal injury in the event of an accident will increase. ◀

**Removal – front**

1. Pull the head restraint upward to the stop
2. Press the button, refer to arrow, and remove the head restraint.

Installation – front

1. Press the button, refer to arrow, and insert the head restraint into the guides
2. Adjust the head restraint for your personal comfort.

Removal and installation – rear

To remove the head restraint, pull it outward with a firm movement. To install it, press it down firmly.



You can make separate adjustments of the backrest tilt angle on the right and left sides.

You can select a comfortable seating position and also increase the capacity of the cargo area by moving the backrests into their most upright position.

From the rear seats: press the corresponding switch.



You can prevent adjustments of the power rear-seat backrest from the rear passenger area with the safety switch for the power windows, refer to page 41. ◀



From the cargo area: the switches are located on both sides of the cargo area.

Safety belts



 In the rear, the belt buckle with the word CENTER is intended exclusively for passengers sitting in the middle. If it is not possible to extract the center belt, this indicates that the larger backrest is not securely locked, refer to page [120](#). ◀

Drive with your safety belt on

Even though there is an airbag, wear a safety belt every time you get in the vehicle, because airbags enhance safety by providing added protection.

To lock

Make sure you hear the lock engage in the belt buckle.



Please fasten safety belts
warning lamp

Lights up either for a few seconds or until the belt is engaged.

To unlock

1. Press the red button in the buckle
2. Hold the belt
3. Guide the belt back into its reel.



Safety belt height adjustment

You can adjust the safety belts to fit your own physical dimensions by using the safety belt height adjustment:

Slide the button up or down as required.

Also observe the instructions on adjusting the seats on page [44](#).

 If the safety belt system has been subjected to the stresses involved in an accident or otherwise damaged: Have the entire safety belt system replaced by your BMW Sports Activity Vehicle center. In addition, have your BMW Sports Activity Vehicle center inspect the safety belt anchors. Otherwise, the safety function can no longer be ensured. ◀



You can store and call up three different seat, exterior mirror and steering wheel positions. The illustration shows the buttons on the seat for making these position adjustments.

 The adjustment of the lumbar support is not stored in the memory. ◀

To store

1. Turn the ignition key to position 1 or 2
2. Adjust the desired positions for the seat, exterior mirror and steering wheel
3. Press the MEMORY button: the indicator lamp in the button comes on
4. Press memory button 1, 2 or 3, as desired: the indicator lamp goes out.

To call up a stored setting

 Do not call up a position from the memory while the vehicle is moving. There is a risk of accident from unexpected movement of the seat or steering wheel. ◀

Convenience function:

1. Open the driver's door after unlocking the vehicle or place the ignition key in position 1
2. Briefly press memory button 1, 2 or 3, as desired.
Movement stops immediately when one of the seat-adjustment or memory buttons is activated during the adjustment process.

Security function:

1. With the driver's door closed and the ignition key either removed or in position 0 or 2
2. Maintain pressure on the desired memory button 1, 2 or 3 until the adjustment process is completed.

 If you press the MEMORY button accidentally: press the button a second time – the indicator lamp goes out. ◀

Seat, mirror and steering wheel memory*

 Your BMW Sports Activity Vehicle center can adjust your vehicle's systems in such a manner that your personalized settings are automatically called up for the seat, mirror and steering wheel positions when you unlock the vehicle with your personal remote control key. ◀

 If you make use of this adjustment, be sure that the footwell behind the driver's seat is unobstructed before unlocking the vehicle. If you fail to do so, persons or objects could be injured or damaged if the seat should move backward. ◀



Passenger side exterior mirror tilt function

Automatic curb monitor

1. Select the driver's mirror via the switch
2. When the gearshift lever or the selector lever is placed in Reverse, the passenger-side mirror tilts downward to help the driver monitor the area directly adjacent to the vehicle during parking – curbs, etc.

You can deactivate this automatic feature by setting the mirror selector switch to the passenger side position.

Seat heating*

51

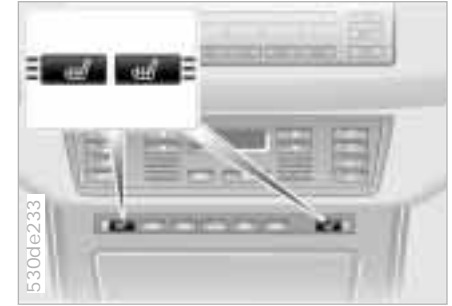

Front

The seat cushion and backrest can be heated when the ignition key is in position 2.

You can call up different heating modes by repeatedly pressing the button.

You can also switch the higher heating modes off directly:

Press the button and hold it slightly longer.



Rear

The function is the same as for front seat heating. You can select between two heating modes.



Adjustment

The steering wheel can be moved in any of four directions. Adjust the steering wheel by moving the control lever in the desired direction.



Do not adjust the steering wheel while the vehicle is moving. If you do so, there is a risk of accident from unexpected movement. ◀

To store the steering wheel setting, refer to Seat, mirror and steering wheel memory on page [50](#).

Automatic steering wheel adjustment

only in conjunction with seat, mirror and steering wheel memory

In order to make it easier to get into and out of the vehicle, the steering wheel automatically moves into the top position and returns to the driving or memory position.

This automatic feature is controlled by the position of the ignition key and by the driver's door.



Steering wheel heating functions in ignition key position 2.

Press the button to activate or deactivate this system.

The indicator lamp within the button lights up when the steering wheel heating is in operation.

If you have a steering wheel with multi-function buttons without steering wheel heating, the button for the recirculated-air mode is in this location, refer to page 23.



Adjusting exterior mirrors

- 1 Mirror switch for 4-way adjustment
- 2 Left/right selector switch
- 3 Button for folding mirror in and out

By pressing button 3 repeatedly, you can fold the mirror in and out. This is, for example, advantageous in car washes, narrow streets or for bringing a mirror folded forward into the proper position again.

 Folding in is possible up to a speed of approx. 6 mph/10 km/h. ◀

 Before going through a car wash, manually, or with button 3 fold the exterior mirrors inward, otherwise they could be damaged, depending on the width of the car wash system. ◀

Adjusting manually

You can also adjust the mirrors manually: Press on the outer edges of their lenses.

To store the mirror settings, refer to Seat, mirror and steering wheel memory on page 50.

Convex mirror

 The passenger-side mirror features a convex lens. When estimating the distance between yourself and other traffic, bear in mind that the objects reflected in the mirror are closer than they appear. This means that estimations of the distance to following traffic should not be regarded as precise. ◀

Self-defrosting mirrors

Both mirrors are defrosted automatically when the ignition key is in position 2.



Interior rearview mirror

To reduce glare from vehicles behind you when you are driving at night, tilt the mirror by turning the button.

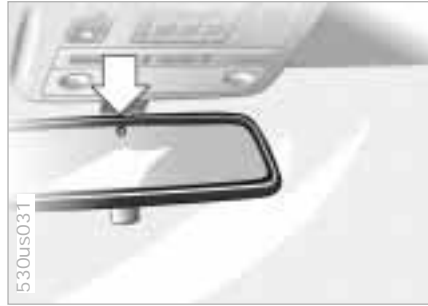

Interior and exterior rearview mirrors with automatic dimmer*

These mirrors automatically dim through an infinitely-variable range. They automatically revert to their undimmed mode whenever the transmission is placed in reverse gear or selector lever in Reverse.

There are two photocells located in the interior rearview mirror for this purpose. One photocell is in the mirror glass, refer to arrow, while the other is offset somewhat on the back of the mirror.

For trouble-free operation, keep the photocells clean and do not cover the area between the interior rearview mirror and the windshield. Do not attach any kind of stickers on the windshield in front of the mirror, either.

Airbags

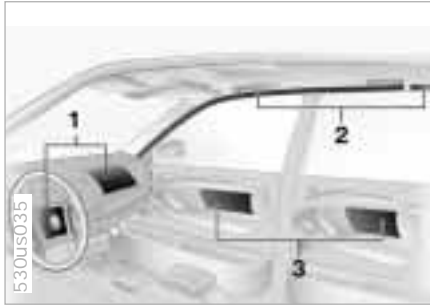

- 1 Front airbag for driver and front passenger
- 2 Side Impact Head Protection System for front and rear
- 3 Side airbags for front and rear*

Protective effect

The front airbags supplement the safety belts by helping to provide additional protection for the front-seat occupants in the event of a severe frontal impact in which the protection afforded by the safety belts alone may no longer be sufficient. The Side Impact Head Protection System and the side airbags help provide protection in the event of a side impact. Each of the side airbags is designed to help support the upper body.

 The side airbags in the rear passenger area* of your vehicle may already have been deactivated either at the time of manufacture or by a BMW Sports Activity Vehicle center. You may have them activated if you desire to do so. Please contact your BMW Sports Activity Vehicle center for additional information. ◀

For information on the correct seating position, refer to page 44.

 The airbags will not be triggered in the event of a minor accident, a vehicle roll-over, or collisions from the rear. ◀

 Do not apply adhesive materials to the cover panels of the airbags, cover them or modify them in any other way. Do not attempt to remove the airbag restraint system from the vehicle. In the event of a malfunction, deactivation, or triggered actuation – as a response to an accident – of the airbag restraint system, consult your BMW Sports Activity Vehicle center for testing, repairs or service operations. Do not modify or tamper with either the wiring or the individual components in the airbag system. These include the padded steering wheel hub, the instrument panel, the side trim panels of the front or rear doors and the roof pillars or the sides of the headliner. Do not remove or dismantle the steering wheel yourself. To ensure compliance with official safety regulations, entrust disposal of airbag generators to a BMW Sports Activity Vehicle center. Unprofessional attempts to service the system could lead to failure in an emergency or undesired airbag activation, either of which could result in personal injury. Do not touch the individual components directly after the system has been triggered, as otherwise there is a danger of burns. ◀



At all times, occupants should sit upright and be properly restrained – infants and small children in appropriate child-restraint systems; larger children and adults using the safety belts.

Never let an occupant's head rest near or on a side airbag because the inflating airbag could cause a serious or fatal injury. Please note that the word Airbag imprinted on the door trim panel indicates the airbag's location.

Accident research shows that the safest place for children in an automobile is in the rear seat. However, a child sitting in the rear seat and not properly restrained may place his or her head on or near the airbag, if so equipped.

For example, a child – even though belted – may fall asleep with his or her head against the side airbag. It may be difficult for a driver to ensure that children in the rear seat will remain properly positioned at all times and do not place their heads on or near the side airbag. Therefore, we recommend that the rear side airbags, if provided, be deactivated if you plan to transport children in the rear seat.

The rear seat side airbags may already have been deactivated, either at the time of manufacture or by a BMW Sports Activity Vehicle center. Labels in the rear door opening should indicate the status of your rear seat side airbags. If you are uncertain of their status, or wish to have the airbags activated or deactivated, please contact your BMW Sports Activity Vehicle center. ◀

Even when all these guidelines are observed, there is still a small residual risk of injuries to the face, hands and arms occurring from airbag deployment in isolated instances. The ignition and inflation noise may provoke a mild temporary hearing loss in extremely sensitive individuals.

Airbag warning information is also provided on both sun visors.



This is the right way a child should sit in a child-restraint device when rear side airbags, refer to arrow, are provided.

Airbags



This is the right way a larger child should sit wearing the safety belt when rear side airbags, refer to arrow, are provided.

Indicator lamp



The indicator lamp in the instrument cluster shows the operational status of the airbag system from ignition key position 1 and up.

System operational:

- ▷ The indicator lamp comes on briefly then goes out.

System malfunction:

- ▷ The indicator lamp fails to come on
- ▷ The indicator lamp comes on briefly before going out and then lighting up again.

If there is a system malfunction, have your BMW Sports Activity Vehicle center inspect the system immediately. If you do not, there is a risk that the airbags will not be triggered within their normal response range, even if the level of impact would normally have triggered them.

58 Transporting children safely

Commercially-available child-restraint systems are designed to be secured with a lap belt or with the lap belt portion of a combination lap/shoulder belt. Improperly or inadequately installed restraint systems can increase the risk of injury to children. Always read and follow the instructions that come with the system.

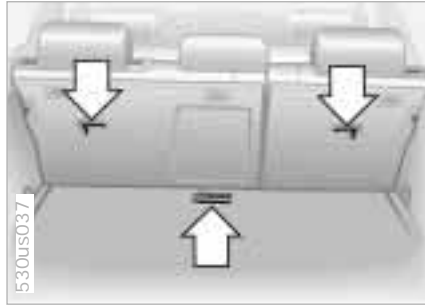

Child-restraint system with tether strap

If you use a child-restraint system with a tether strap, three additional tether anchorage points have been provided – refer to the arrows in the illustration. Depending on the location selected for seating in the rear passenger area, attach the tether strap to the corresponding anchorage point to secure the child-restraint system, as shown in the illustration below.

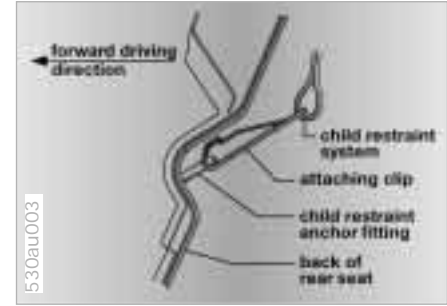

Each seating position is fitted with a head restraint.

Outer seating positions:
Lift the head restraint and pass the tether strap between the head restraint and the seat back. It is recommended to readjust the head restraint into the lowest possible position.

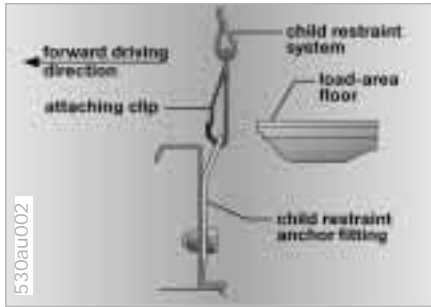

Center seating position:

The head restraint must be adjusted into the lowest possible position. Pass the tether strap over the head restraint.

Adjust the tether strap according to the child restraint manufacturer's instructions.



Before installing any child-restraint device or child seat, please read the following:

Never install a rearward-facing child-restraint system in the front passenger seat of this vehicle.

Your vehicle is equipped with an airbag supplemental restraint system for the front passenger. Because the backrest on any rearward-facing child-restraint system, of the kind designed for infants under 1 year and 20 lbs/9 kg, would be within the airbag's deployment range, you should never mount such a device in the front passenger seat, since the impact of the airbag against the child restraint's backrest could lead to serious or fatal injuries.

If it is necessary for a child, not an infant, to ride in the front seat, certain precautions should be taken. First, move the passenger seat as far away from the instrument panel as possible. This important precaution is intended to maximize the distance between the airbag and the child. Older children should be tightly secured with a safety belt, after they have outgrown a booster seat that is appropriate for their age, height and weight.

Younger children should be secured in an appropriate forward-facing child-restraint system that has first been properly secured with a safety belt. Never install a rearward-facing child-restraint system in the front passenger seat.

We strongly urge you to carefully read and comply with the instructions for installation and use provided by the child restraint's manufacturer whenever you use such a device. Be sure that all occupants, of all ages, remain properly and securely restrained at all times. ◀

All rear seating positions in your vehicle meet the recommendations of SAE J1819, an industry-recommended practice for securing child-restraint systems in motor vehicles.

60 Transporting children safely



Child-restraint system security

All of the rear belt retractors and the front passenger's safety belt can be locked for mounting and securing child-restraint systems. Information regarding this is located near the buckle latch of each safety belt.

Lock the safety belt

Pull the entire length of the belt from the belt retractor. Allow the reel to retract the belt somewhat and engage the buckle, then tighten the belt against the child-restraint system. The retraction mechanism is now locked.

Release the safety belt

Release the buckle, remove the child-restraint device and allow the belt retractor to reel the belt completely in.



LATCH child-restraint system

LATCH: Lower Anchors and Tethers for Children

The rear outer seating positions are provided with anchorage points for a LATCH child-restraint system. The illustration shows the anchorage points in the left rear seat as an example.

Canadian models only:

The anchorage points for the LATCH child-restraint system are indicated by buttons, refer to illustration.

Remove cover panel by pulling it off toward the front.

Simply put it back on to reattach it.



To install a LATCH child-restraint system, please follow the manufacturer's operating instructions and safety precautions. ◀



Child-safety locks

Slide the safety lever on the rear doors downward:

The door can now be opened from the outside only.

Vehicle Memory, Key Memory



How the system functions

You have probably frequently wished that you could configure individual functions of your vehicle to reflect your own personal requirements. In engineering your vehicle, BMW has included several user-defined functions in the vehicle's design. Your BMW Sports Activity Vehicle center can make these settings for you.

There are settings related to the vehicle – Vehicle Memory – and settings related to individuals – Key Memory. You can configure up to four different basic positions for four different persons. The only requirement is that each person uses his or her own remote control key.

When your vehicle is unlocked with the remote control, the vehicle recognizes the individual user by means of a data exchange with the key, and makes adjustments accordingly.

In order for you to distinguish between the remote control master keys, colored decals are supplied together with the keys.

What the system can do

Your BMW Sports Activity Vehicle center can provide you with details on the capabilities of the Vehicle Memory and Key Memory systems. A few examples follow below:

Examples for Vehicle Memory:

- ▷ Various signals that can serve as acknowledgment for locking and unlocking the vehicle, refer to pages [31](#), [34](#)
- ▷ Deactivating/activating the Follow me home lamps function, refer to page [99](#).

Examples for Key Memory:

- ▷ Automatic adjustment of the driver's seat, outside mirror and steering wheel with settings stored in the memory for the individual driver when the vehicle is unlocked, refer to page [51](#)
- ▷ Calling up customized settings for the automatic climate control when unlocking the vehicle, refer to page [107](#).



You will see this symbol throughout the Owner's Manual. It is to remind you at appropriate places of the settings that are available to you. ◀

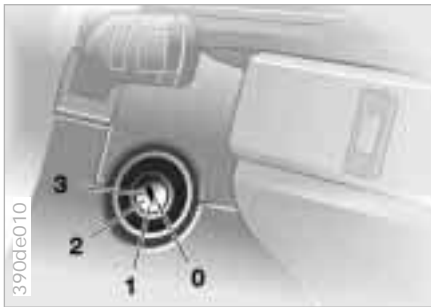

Ignition key positions

- 0 Steering lock engaged
- 1 Steering lock disengaged
- 2 Ignition on
- 3 Starting the engine

Steering lock engaged

The key can only be inserted or removed in this position.

After removing the key, turn the steering wheel slightly to the left or right until you hear the lock engage.

Once the ignition has been switched off – ignition key in position 0 or removed – the radio functions are still available for approx. 20 minutes. Turn the radio back on to use it.

An acoustic warning is sounded when you fail to remove the ignition key after opening the driver's door.

 Vehicles with automatic transmission:

Do not move the selector lever from the Park position until the engine is running – ignition key in position 2.

In order to turn the key to position 0 or to remove it, first move the selector lever to the Park position – Interlock. ◀

Steering lock disengaged

You will find that it is often easier to turn the ignition key from position 0 to position 1 when you move the steering wheel slightly to help disengage the lock.

Individual electrical devices are ready for operation.

Starting the engine

 Vehicles with manual transmission: depress the clutch when starting the engine. If you do not, a lock prevents the engine from starting. ◀

Starting the engine

Before starting

- ▷ Engage the parking brake
- ▷ Be sure that the gearshift lever is in Neutral or the selector lever in Park if the vehicle is equipped with an automatic transmission
- ▷ Depress the clutch pedal.

 Do not allow the engine to run in enclosed spaces. Breathing the exhaust gases poses an extreme health risk, and can lead to unconsciousness and death. The exhaust gases contain carbon monoxide, an odorless and colorless, but highly toxic gas.

Do not leave the vehicle unattended with the engine running, since an unattended vehicle with a running engine represents a safety hazard. ◀

 When driving, standing at idle, and parking the vehicle, take care to avoid contact between the hot exhaust system and flammable materials, e.g. grass, hay, leaves, etc. Such contact could lead to a fire, resulting in serious personal injury and property damage. ◀

Starting the engine

Do not press the accelerator pedal while starting the engine.

 **BMW X5 3.0i:**
Do not actuate the starter for too short a time. Do not turn it for more than approx. 20 seconds. Release the ignition key immediately as soon as the engine starts.

BMW X5 4.4i, 4.6is:
Your BMW is equipped with the convenience starting feature. Simply turn the ignition key to position 3 – starter – and then release it immediately. The starter actuation continues to operate automatically for a certain period of time and is stopped automatically as soon as the engine has started. The automatic starting mode will not operate if the battery voltage is low. The engine can be started by means of jump-starting, refer to page [162](#). ◀

Do not allow the engine to warm up by leaving it running while the vehicle remains stationary. Instead, begin to drive immediately at a moderate engine speed.

Should the engine fail to start on the first attempt, if it is very hot or cold, for instance:

▷ Press the accelerator pedal halfway down while engaging the starter.

Cold starts at altitudes above 3,300 ft/ 1,000 meters and at very low temperatures, from approx. +5 °F/-15 °C:

▷ For the initial start attempt, allow the starter to remain engaged somewhat longer, approx. 10 seconds.

Engine idle speed is controlled by the engine computer system. Increased speeds at start-up are normal and should decrease as the engine warms up. If engine speed does not decrease, service is required.

To prevent the battery from discharging, always switch off electrical devices that are not in use. Switch the ignition off when the vehicle is not being driven.

 Extended starting attempts, characterized by excessively frequent or long periods with the starter engaged, can lead to damage of the catalytic converter. ◀

Switching off the engine 63

Turn the ignition key to position 1 or 0.

 Do not remove the ignition key while the vehicle is still moving. If you do so, the steering will lock. Always remove the ignition key and engage the steering lock before leaving the vehicle.

Vehicles with manual transmission: Always engage the parking brake when parking on slopes and inclined surfaces. Even placing the gearshift lever in 1st gear or reverse may not provide adequate resistance to rolling. Vehicles with automatic transmission: Place the selector lever in Park. ◀

Vehicles with automatic transmission: The vehicle must be stationary and the selector lever in Park before you can remove the ignition key.



The parking brake is primarily designed to prevent the vehicle from rolling while parked. It operates against the rear wheels.

To engage

The lever engages automatically when you pull it up and the indicator lamp comes on in the instrument cluster in ignition key position 2, refer to pages [19](#) and [20](#).

To release

Pull up slightly on the lever, press the button and lower the lever.

⚠ If, in exceptional circumstances, it should be necessary to engage the parking brake while the vehicle is in motion, do not pull it with excessive pressure. Keep your thumb pressed against the release button while carefully pulling up the lever to apply moderate pressure. Excessive pressure can lead to over-braking and loss of traction – fishtailing – at the rear axle.

The brake lamps do not come on when the parking brake is engaged.

Vehicles with manual transmission:

Always engage the parking brake when parking on slopes and inclined surfaces. Even placing the gearshift lever in 1st gear or reverse may not provide adequate resistance to rolling.

Vehicles with automatic transmission:

Place the selector lever in Park. ◀

To avoid corrosion, apply the parking brake lightly from time to time when coasting to a standstill at a traffic signal, for instance, provided that it is safe to do so.



Press the clutch pedal all the way down each time you shift, pressing the gearshift lever into its proper end position.

Depress the clutch when starting the vehicle, too, otherwise, the interlock will prevent the engine from starting if the clutch is not depressed.

Reverse

Select Reverse only when the vehicle is completely stopped. Press the gearshift lever to the left to overcome the resistance.

As you do this, the backup lamps will turn on automatically when the ignition key is in position 2.



Do not hold the vehicle in place on slopes by slipping or riding the clutch. Use the parking brake instead, since a slipping clutch increases clutch wear. ◀



You can drive as with a normal automatic transmission. In addition, you can also shift manually.

When you move the selector lever from the D position to the left into the M/S range, the performance-oriented shift programs of the automatic transmission are engaged. As soon as you tap the selector lever in the + or – direction, Steptronic changes the gear. The manual mode is engaged. When you wish to use the automatic transmission mode again, move the selector lever to the right into the D position.

Under normal operating conditions, fuel consumption is lowest when driving in position D.



Selector lever positions

P R N D M/S

The transmission range display varies according to the equipment of your vehicle, refer to the illustrations.

Starting the engine

The engine can only be started in selector lever positions Park or Neutral.



Range selection

A detent prevents inadvertent shifts to the Reverse or Park selector lever positions. To disengage the detent, press the button on the front side of the selector lever knob, refer to arrow.



While the vehicle is stationary and before shifting out of Park or Neutral, depress the footbrake in order to disengage the selector lever's lock mechanism – Shiftlock.

Hold the footbrake down until starting off. The vehicle will otherwise creep when a drive position is engaged. ◀



If you leave the vehicle with the engine running, move the selector lever to the Park position and engage the parking brake. If you fail to do this, the vehicle could move.

Do not leave the vehicle unattended with the engine running, since an unattended vehicle with a running engine represents a safety hazard. ◀

P Park

Select only when the vehicle is stationary. The transmission locks to prevent the rear wheels from turning.

R Reverse

Select only when the vehicle is stationary.

N Neutral – Idle

Select only if your journey is interrupted for a longer period.

D Drive – Automatic shift program

This position is designed for driving under all normal operating conditions. All forward gears are available.

Kickdown

In the kickdown mode, you achieve maximum acceleration and in position D top speed.

Depress the accelerator pedal past the increased resistance point at the full-throttle position.



M/S Manual mode and Sport Program

When you change from D to M/S, the Sport Program is activated. This is indicated by D S in the transmission range display. The Sport Program is designed for performance-oriented driving.

With the first brief touch, the automatic transmission shifts from the Sport Program to the manual mode.

Whenever you tap the selector lever in the + direction, the transmission shifts up, and when you tap it in the – direction, the transmission will shift down. Depending on the equipment version, 1 to 5 or M1 to M5 is indicated in the transmission range display.

Upshifts or downshifts will only be carried out at appropriate engine speeds and road speeds. If the engine speed is too high, for instance, the downshift will not be executed. The gear selected will appear briefly in the instrument cluster followed by the current gear.

 If you are driving in the manual mode and wish to accelerate rapidly – to pass another vehicle, for example – shift down manually or with the kickdown function. ◀

You can only change from M/S to selector lever positions P, R and N via the D position.

Electronic transmission control module



If the indicator lamp comes on or the message – TRANS.FAIL-SAFE PROG – appears in the Check Control, there is a fault in the transmission system.

Bring the vehicle to a stop. Move the transmission selector lever to P. Set the parking brake and switch the engine off, ignition key to position 0.

Wait a few seconds, then start the engine.

If the indicator lamp goes out after a few seconds, normal transmission performance has been restored. You may continue to drive as usual. If the indicator lamp does not go out, you can place the selector lever in all positions. However, the vehicle will now only drive forward with limited gear selection.

If this happens, avoid extreme engine loads and consult the nearest BMW Sports Activity Vehicle center.



Do not work in the engine compartment when a drive gear is engaged. If you do this, the vehicle could move. ◀

Information on jump-starting, tow-starting and towing begins on page [162](#).

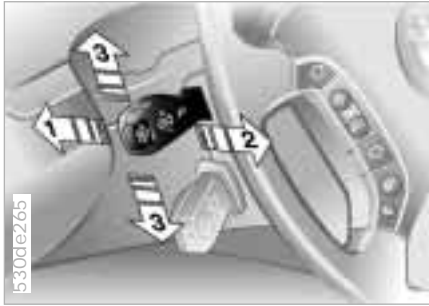

- 1 High beams – blue indicator
- 2 Headlamp flasher – blue indicator
- 3 Turn signal indicators – green indicator accompanied by periodic clicking sound from the relay

To signal briefly

Press the lever up to but not beyond the pressure point. It then returns to the center position when released.

 If the indicator lamp and the clicking from the relay are both faster than normal, one of the turn signal indicators has failed. ◀

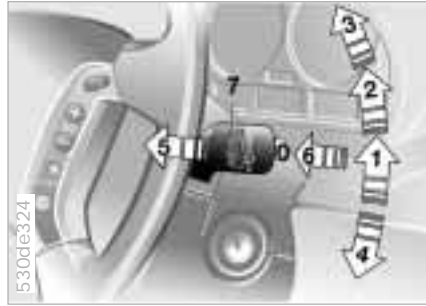

- 0 Wipers retracted
- 1 Intermittent mode or rain sensor
- 2 Normal wipe
- 3 Fast wipe
- 4 Brief wipe
- 5 Clean the windshield
- 6 Special wash program*
- 7 Rotary dial for control of the wipe interval or the sensitivity of the rain sensor

Wipers retracted – home position

The left wiper is partially concealed by the hood. In order to bring the wipers to roughly a vertical position – this is important for changing the wiper blades or to fold the wipers out during frosty weather, for example:

▷ With the lever in position 1, switch off the ignition as soon as the wipers come to a stop.

If equipped with a rain sensor:

1. Switch on the wipers with the lever in position 1, 2 or 4
2. When the wipers are approx. vertical, switch the ignition off.

For changing the wiper blades, refer to page [150](#).

 Fold the wipers back down onto the windshield before you turn the ignition key to position 1 or 2 again. If you do not, they could be damaged. ◀

Washer/Wiper system/Rain sensor*

Intermittent mode

Not on vehicles with rain sensor.

You can set the wipe interval to four stages with rotary dial 7.

In addition, the wipe interval is varied automatically depending on road speed.

Rain sensor

The rain sensor is positioned on the windshield, directly in front of the interior rearview mirror.

To activate the rain sensor:

Move the lever to position 1 with the ignition key in position 1 or higher. The wipers travel once across the windshield, regardless of the weather conditions.

You can leave the lever permanently in position 1. It is then only necessary to activate the rain sensor from ignition key position 1 and up.

To do this, turn rotary dial 7 briefly.

To adjust the sensitivity of the rain sensor:

Turn rotary dial 7.

Deactivating the rain sensor:

Move lever to position 0.



Switch the rain sensor off in automatic car washes. If you do not, damage may occur if the wipers switch on unintentionally. ◀

Normal wipe

The system switches automatically to intermittent mode when the vehicle is not moving, not on vehicles with rain sensor.

Fast wipe

The wipers operate at normal speed when the vehicle is not moving, not on vehicles with rain sensor.

Clean the windshield

The system sprays washer fluid against the windshield and activates the wipers for a brief period.

Special wash program*

As at 5; there are also several additional wash cycles, and the headlamps are cleaned*.

This program is recommended after you have driven on extremely dirty roads.

Clean the headlamps*

- ▷ With the special wash program 6
- ▷ With every actuation of clean the windshield 5 when the vehicle's lighting is switched on, the headlamps will be cleaned at appropriate intervals.

70 Washer/Wiper system/Rain sensor*



Do not use the washers if there is any danger that the fluid will freeze on the windshield. If you do so, your vision could be obscured. For this reason, use an antifreeze agent, refer to page 141.

Do not use the washers when the reservoir is empty. This could cause damage to the washer pump. ◀

Windshield washer jets

The windshield washer jets are warmed automatically when the ignition key is in position 2.



Rear window wiper

- 0 Retracted position of the rear window wiper
- 1 Rear window wiper in intermittent mode. When reverse gear is engaged, continuous operation is switched on automatically
- 2 Clean the rear window

You can also program the interval:

- ▷ Switch briefly from position 0 to position 1
- ▷ The time until reactivation – from position 0 to 1 – is the programmed interval, max. 30 seconds.

Programming is deleted:

- ▷ Approx. 10 seconds after the lever is placed in position 0 or
- ▷ after the engine is switched off.

For changing the wiper blade, refer to page 150.

Cruise control*

You can automatically maintain and store any desired vehicle speed above approx. 20 mph/30 km/h.

You can use cruise control whenever the system is active while the engine is running.

To activate the system



From ignition key position 2: Press button; the indicator lamp in the instrument cluster comes on, refer to page 22. You can now use the cruise control.



Do not use cruise control on twisting roads, when high traffic density prevents driving at a constant speed, when the road surface is slick – snow, rain, ice – or when the road surface is loose – rocks, gravel or sand. ◀

To deactivate the system



Press the button repeatedly until the indicator lamp in the instrument cluster goes out.

The cruise control is also deactivated when the ignition key is turned into position 0.

The speed stored in the memory is deleted.

To maintain and store speed or to accelerate



Press button + briefly: The system maintains and stores the current vehicle speed. Every time you briefly touch the button, the speed increases by approx. 0.6 mph/1 km/h.

Press and hold button + : The vehicle accelerates without pressure on the accelerator pedal. When you release the button, the system maintains and stores the current speed.



If, on a downhill gradient, the engine's braking effect is not sufficient, the controlled speed can be exceeded. Speed can drop on uphill grades if the engine output is insufficient. ◀

To decelerate



Press button – briefly:

When cruise control is active, every brief touch of the button reduces the speed by approx. 0.6 mph/1 km/h.

Press and hold button –:

With the cruise control active, the system automatically reduces the throttle opening to slow the vehicle. When you release the button, the system maintains and stores the current speed.

To interrupt the cruise control



When the system is activated, press button 1. The indicator lamp stays on. You can use the cruise control again whenever required by calling up the speed that was stored last.

In addition, the system is automatically interrupted in response to the following conditions:

- ▷ When you apply pressure to the brake pedal
- ▷ When you apply pressure to the clutch pedal or when you move the automatic transmission selector lever from Drive to Neutral
- ▷ If you exceed or fall below the controlled speed for an extended period, by depressing the accelerator, for example.

To recall the stored setting



Press button:

The vehicle accelerates to and maintains the last speed stored.



- 1 Odometer
- 2 Trip odometer
- 3 Outside temperature display

Odometer

You can activate the displays shown in the illustration with the ignition key in position 0 by pressing the button in the instrument cluster, refer to arrow.

The range of available displays varies according to your individual vehicle's equipment.

Trip odometer

To reset the trip odometer to zero, press the button, refer to arrow, with the ignition key in position 1 or 2.

Outside temperature display

The outside temperature appears in the display from ignition key position 1 and higher.

You can change the units of measurement - °C/°F - by

1. pressing and holding down the button, refer to arrow, with the ignition key in position 1
2. and then turning the ignition key to 0. At the same time the units of measurement in the temperature display of the automatic climate control will be changed, refer to page 105.

Refer also to page 80.

Ice warning

If the outside temperature drops to approx. +37.5 °F/+3 °C, a signal sounds as a warning and the display flashes for a brief period.

 The ice warning does not alter the fact that surface ice can form at temperatures above +37.5 °F/+3 °C, on bridges or shaded road surfaces, for instance. ◀

**BMW X5 3.0i, 4.4i**

Do not operate the engine with the needle in the red overspeed zone of the gauge, refer to arrow.

To protect the engine, the engine management system automatically interrupts the fuel supply in this range.

**BMW X5 4.6is**

The orange pre-warning zone displays current permissible engine speeds, depending on the engine temperature. As the engine temperature increases, some of the sectors for this pre-warning zone will go out one after the other.

Avoid engine speeds in the pre-warning zone if possible.

Do not operate the engine with the needle in the red overspeed zone of the gauge, refer to arrow.

To protect the engine, the engine management system automatically interrupts the fuel supply in this range.

**BMW X5 3.0i, 4.4i**

Indicates the current fuel consumption in mpg, on Canadian vehicles in liters/100 km. This allows you to see whether your current driving style is conducive to fuel economy with minimum exhaust emissions.

When the vehicle is stationary, the display goes to Maximum – zero on Canadian models.

Temperature gauge



BMW X5 4.6is

The general operating temperature is between 176 °F/80 °C and 248 °F/120 °C. Do not exceed the maximum temperature of 302 °F/150 °C.

Fuel gauge



If the indicator lamp comes on and stays on, there are approx.

- ▷ 2.0 gal./8 liters – 6-cylinder engine
 - ▷ 2.5 gal./10 liters – 8-cylinder engine
- of fuel still in the tank.

Tank capacity: approx. 24.6 gal./
approx. 93 liters.

Certain operating conditions where the tilt of the vehicle varies, such as those encountered in mountainous areas, may cause the needle to fluctuate slightly.

 Do not drive until the tank is completely empty, as otherwise engine functions are not ensured and damage can occur. ◀

When you switch on the ignition, the indicator lamp comes on briefly to confirm that the system is operational.

76 Coolant temperature gauge



Between the blue and red zones

Normal operating range. It is not unusual for the needle to rise as far as the edge of the red zone.

Blue

The engine is still cold. Drive at moderate engine and vehicle speeds.

Red

When you switch on the ignition, the warning lamp comes on briefly to confirm that the system is operational.

If the warning lamp comes on while driving or the message - COOLANT TEMPERATURE - appears in the Check Control: the engine is overheated. Switch off the engine immediately and allow it to cool down.

Checking coolant level, refer to page [143](#).

Service Interval Display



The range of available displays varies according to your individual vehicle's equipment.

Green lamps

The number of illuminated lamps decreases as the time for your next maintenance visit approaches.

Yellow lamp

This field appears together with OILSERVICE or INSPECTION.

Maintenance is due. Please contact your BMW Sports Activity Vehicle center for an appointment.

Red lamp

The maintenance deadline has been passed.

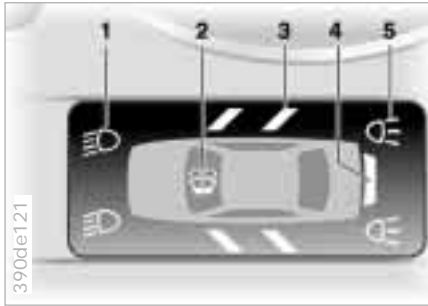

Graphic display*

The following alerts or status messages are displayed with icons from ignition key position 2 and up until the defects are corrected:

- 1 Check low beams
- 2 Add washer fluid (goes out after approx. 1 minute)
- 3 Door open
- 4 Tailgate open
- 5 Check brake and tail lamps. A defective center brake lamp is indicated by the upper symbol.

When you open the door after stopping, a warning signal sounds without a visual indicator for:

- ▷ LIGHTS ON
- ▷ KEY IN IGNITION LOCK.



Alphanumeric display*

Text messages are used to alert the driver to system malfunctions when the ignition key is turned to position 2. The alert is accompanied by an acoustic signal.

- 1 Status messages symbol
- 2 Display
- 3 CHECK button

Messages concerning system faults are differentiated based on two priorities:

Priority 1

These defects are immediately indicated by an acoustic signal and a flashing warning symbol 1. Simultaneous defects will be displayed consecutively. These status messages remain in the display until the defects are corrected. They cannot be deleted by pressing the CHECK button 3:

- ▷ RELEASE PARKINGBRAKE
- ▷ COOLANT TEMPERATURE
 - The coolant is overheated. Stop the vehicle immediately and switch off the engine, refer to pages 76 and 143
- ▷ STOP!ENGINE OILPRESS
 - The oil pressure is too low. Stop the vehicle immediately and switch off the engine, refer to pages 19 and 141

▷ CHECK BRAKE FLUID

Indicates that brake fluid is down to approximately the minimum level. Top off the brake fluid at the next opportunity, refer to page 144. Have the cause of the brake fluid loss diagnosed and corrected by your BMW Sports Activity Vehicle center

▷ TIRE LOW/FLAT*

Reduce vehicle speed immediately and stop the vehicle. Avoid hard brake applications. Do not oversteer, refer to page 98

▷ SELFLEVEL SUSP.INACT*

Please consult the nearest BMW Sports Activity Vehicle center

▷ SELFLEVEL SUSP.INACT*

max. 35 mph/max. 60 km/h*
These displays appear consecutively. Do not exceed a maximum speed of 35 mph/60 km/h.

Please consult the nearest BMW Sports Activity Vehicle center

▷ LIMIT*

You will see this message if the programmed speed limit has been exceeded, refer to page 85.

Priority 2

These displays appear for 20 seconds when the ignition key is turned to position 2. The warning symbols remain after the message disappears. You can call up the messages again for display by pressing the CHECK button.

▷ TRUNKLID OPEN

This message appears only at the start of a trip

▷ DOOR OPEN

This message appears after a minimal defined road speed has been exceeded

▷ FASTEN SEAT BELTS*

In addition to this message, an indicator lamp with the safety belt icon appears and an acoustical signal is sounded

▷ WASHER FLUID LOW

The fluid level is too low; top off at the next opportunity, refer to page 141

▷ CHECK ENGINE OIL LEV

The oil level is at the absolute minimum; refill as soon as possible, refer to page 141. Do not drive more than approx. 30 miles/50 km until you add oil

▷ CHECK FILLER CAP

Check to see whether the fuel filler cap has been closed properly, refer to page 25

▷ OUTSIDE TEMP. +23 °F/-5 °C

This display is only an example. The current temperature is displayed at outside temperatures of +37.5 °F/+3 °C and below, refer also to page 73

▷ TIRE PRESSURE SET*

The RDC has imported the current inflation pressure in the tires as the target values which the system will monitor, refer to page 97

▷ CHECK TIRE PRESSURE*

Check and correct the tire inflation pressure to specifications at the earliest opportunity, e.g. next stop to refuel, refer to page 97

▷ TIRECONTROL INACTIVE*

A temporary interference of the RDC or a system fault, refer to page 98

▷ CHECK BRAKE LIGHTS

A lamp has failed or the electrical circuit has a fault, refer to page 153 or consult a BMW Sports Activity Vehicle center

Check Control

- ▷ CHECK LOWBEAM LIGHTS
CHECK SIDE LIGHTS
CHECK REAR LIGHTS
CHECK FRONT FOGLAMPS
CHECK LICPLATE LIGHT
CHECK HIGHBEAM LIGHT
CHECK BACK UP LIGHTS
Defective bulb or circuit, refer to page [151](#) or consult a BMW Sports Activity Vehicle center
- ▷ TRANS. FAILSAFE PROG *
Please consult the nearest BMW Sports Activity Vehicle center, refer to page [67](#)
- ▷ CHECK BRAKE LININGS
Have the brake pads inspected by your BMW Sports Activity Vehicle center, refer to page [133](#)
- ▷ CHECK COOLANT LEVEL
Coolant too low, top off at the next opportunity, refer to page [143](#)
- ▷ ENGINE FAILSAFE PROG
There is a fault in the engine's electronic control system.
You can continue to drive with reduced engine output or engine speed.
Have the system checked by your BMW Sports Activity Vehicle center.

Displays after completion of trip

All of the malfunctions registered during the trip appear consecutively when the ignition key is turned to position 0.

The following displays will appear when appropriate:

- ▷ LIGHTS ON
- ▷ KEY IN IGNITION LOCK
- ▷ CHECK ENGINE OIL LEV
Add engine oil at the next opportunity, e.g. next stop to refuel, refer to page [141](#).

This display appears when you open the driver's door after parking the vehicle. A supplementary acoustic signal is also heard.

Status messages remain available for a period of approx. three minutes after the display goes out and the key is removed from the ignition lock. Press the CHECK button 3. If there were multiple messages, press the CHECK button repeatedly to view them all in sequence.

To check the Check Control

Press the CHECK button 3 with the ignition key in position 2:
CHECK CONTROL OK appears in the display.

No malfunctions are present in the monitored systems.

Computer

You can find a description of the computer on pages [80](#) and [85](#) as well as in the Owner's Manual for the Onboard Computer.



You can have the Check Control and computer messages displayed in a different language. ◀

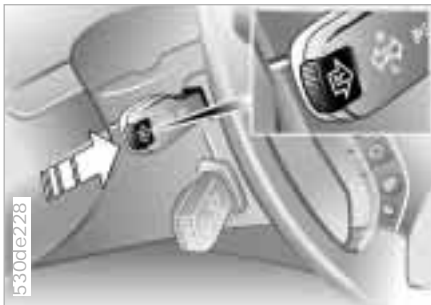

Mode selection

From ignition key position 1 and up, you can call up information from the computer using the button in the turn signal lever. By pressing the button briefly in the direction of the steering column, you can call up a new function for display.

The displays appear in the following order: outside temperature, average fuel consumption, cruising range, average speed.

Starting with ignition key position 1, the last active setting is displayed.

The range of available displays varies according to your individual vehicle's equipment.



Outside temperature and average fuel consumption

You can change the units of measurement – °C/°F – for the outside temperature display by

1. pressing and holding the trip odometer reset button with the ignition key in position 1
2. and then turning the ignition key to 0. At the same time the units of measurement in the temperature display of the automatic climate control will be changed, refer to page 105.

Refer also to page 73.

Cruising range and average speed

The computer bases its calculations of the cruising range on the previous driving style and conditions.

The computer ignores any time spent with the vehicle stationary and the engine switched off in its average speed calculations.

To cancel the display

If the button in the turn signal lever is pressed briefly while the average speed is displayed, the computer display can be masked out.

To restart calculations

If you continue to press the button in the turn signal lever, the average values which were just displayed for fuel consumption and speed will be recalculated from that point. The engine must be running for this calculation.

Computer with alphanumeric display*

If your vehicle has Check Control with alphanumeric display, the system's computer is described beginning on page 85 and in the Owner's Manual for the Onboard Computer.

Multi-Information Display MID

Central display

The MID serves as the central display and operation for the following onboard systems:

- ▷ Digital clock, e.g. time display, date
- ▷ Audio systems – radio, cassette, CD
- ▷ Computer, e.g. fuel consumption, cruising range
- ▷ Cellular phone, e.g. dialing.

You will find explanations and notes for operating the digital clock and the computer on the following pages. Please refer to the separate Owner's Manuals for operating the audio systems, the cellular phone and the onboard computer.

 Any unrealistic numerical entries will not be accepted.

All stored data will be lost if the power supply is interrupted. Time display, switch-on times for independent heating and ventilation, distance and cruise control speed limit may have to be reset once the power supply has been re-established. ◀



- 1 Function button for audio systems
- 2 Function button for the cellular phone
- 3 Indicator lamp for independent ventilation
 - ▷ remains on if switch-on time is active
 - ▷ flashes while operating
- 4 Function button for the digital clock and computer
- 5 Indicator display for the various onboard systems
- 6 Display for the entry and query buttons. Depending on the operating mode, the functions and alternatives that can be selected at the buttons are displayed here
- 7 Entry and query buttons for operating the various onboard systems

82 Digital clock in the MID

 Only make entries when the vehicle is stationary – to avoid endangering yourself or other road users. ◀

To call up time or date



Press the left side of the button.

Display shows:



You can have the time displayed in 12 or 24 hours.

To change the display:



Press the left side of the button.

If the 12-hour time display is in use, AM or PM appears after the time.

To change the time



Press the left side of the button.



Press the right side of the button:
The dots flash in the display.

To change the setting:



Press on the left or right, or hold the button down.

To store the entry:



Press the right side of the button.

To change the date



Press the left side of the button.



Press.



Press the right side of the button:
The dots and the DATE display flash.

To change the setting:



Press on left or right, or hold the button down.

To store the entry:



Press the right side of the button.

The clock takes leap years into account and therefore does not have to be reset manually.

Digital clock in the MID

Reminder signal

You can program a reminder signal – Memo – to be heard every hour, so that you are sure not to miss a news broadcast.



Press the left side of the button.

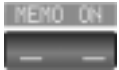

Press:

MEMO OFF appears in the display for entry and query buttons, and the tone symbol will appear in the upper right of the display.

A signal is then heard 15 seconds before each hour.

Stopwatch



Press the left side of the button.



Press.

Display shows:



To start the stopwatch function:



Press the right side of the button.

To take an intermediate time reading:



Press.



Press.

The stopwatch display can be seen counting up; the stopwatch continues to run.

To halt the stopwatch:



Press the right side of the button.

 The stopwatch is halted when the ignition key is turned back to 0, but starts to run again when the ignition key is turned to 1. ◀

84 Digital clock in the MID

Enter the switch-on times for the independent ventilation

You can enter two different switch-on times.

The ventilation will shut off automatically after 30 minutes.

 Please follow the instructions for operating the independent ventilation that start on page [111](#). ◀



Press the left side of the button.



Press on the left/right.

Display shows:



Press the right side of the button: Display flashes, e.g. TIMER 1.

To enter the time:



Press on the left/right, or hold the button down.

To confirm the entry:



Press the right side of the button.

The activated time is marked with an asterisk.



The switch-on times remain stored until new entries are made.

You can change switch-on times that have already been stored by making a new time entry as described above.

When the switch-on time is active, the LED comes on in the MID. During actual operation of the ventilation, the LED flashes. The LED goes out when the system is switched off.

To activate/deactivate the time:



Press twice.

Directly switching the independent ventilation on and off

 The independent ventilation function can only be called up in ignition key position 1. ◀



Press the left side of the button.



Press.

Computer* in the MID

 Only make entries when the vehicle is stationary – to avoid endangering yourself or other road users. ◀

Computer calculations begin at the start of the journey.
Information can also be called up in the display by remote control, refer to page 89.

Speed limit

Speed limit entry:

You can enter the road speed here at which you wish to hear and see a reminder signal: a signal will sound, the word LIMIT will flash, and with the Check Control with alphanumeric display*, the speed limit warning stored in the memory will appear on the instrument cluster briefly.

The speed limit reminder is only repeated if road speed has fallen at least 3 mph/approx. 5 km/h below the preset speed limit.



Press the right side of the button.



Press.



Press the right side of the button.

Display shows:



Enter the limit by pressing the function buttons.

To correct an entry:



Press the left side of the button and repeat the entry.

To store the entry:



Press the right side of the button.

86 Computer* in the MID

Adopting the current speed as the speed limit:



Press the right side of the button.



Press.



Press twice at right.

Deactivating the speed limit:



Press the right side of the button.



Press.

The LIMIT display goes out, but the stored value is not lost and can be reactivated by pressing the LIMIT button.

Distance to destination

The remaining distance to the destination will be displayed on the screen. Enter the entire distance before starting the journey.

To enter:



Press the right side of the button.



Press the left side of the button.



Press the right side of the button.

Display shows:



You can enter the distance by pressing the function buttons.

To correct an entry:



Press the left side of the button and repeat the entry.

To store the entry:



Press the right side of the button.

Checking stored value:



Press the right side of the button.



Press the left side of the button.

Computer* in the MID

Estimated time of arrival

When you have entered the distance to your destination, you can obtain an estimated time of arrival display which is continuously updated by the computer as your average driving period varies.



Press the right side of the button.



Press the right side of the button:
The estimated time of arrival is displayed.

Cruising range

The distance which the vehicle should cover on the remaining fuel in the tank is displayed.



Press the right side of the button.



Press:
The display shows the probable range.



When you have only enough fuel left to drive fewer than 30 miles/50 km, then refuel, as otherwise engine functions are not ensured and damage can occur. ◀

The computer will only register fuel amounts over 1.8 gal/6 liters.

Fuel consumption

You can have the average fuel consumption displayed for two different distances, for example a complete journey and part of the journey.

To start the calculation, select the CONS function with the engine running.



Press the right side of the button.



Press the left or right side of the button:
The display will show the average fuel consumption.

To restart the fuel consumption calculation:



Press the left or right side of the button.



Press the right side of the button.

Speed

You can call up a display of the vehicle's average speed.

To start the calculation, select the SPEED function with the engine running.



Press the right side of the button.



Press:

The display shows the average speed.

To recalculate the speed:



Press the right side of the button.

Extended immobilizer function

You can establish a code that will prevent the engine from being started unless the code is entered.

If you do not have access to the code, the emergency deactivation procedure will have to be carried out, refer to next page.

Establishing and activating the code:



Press the right side of the button.



Press the left side of the button.

Display shows:



Enter the code with the function buttons.

To correct an entry:



Press on the left side of the button and repeat the entry.

To store the entry:



Press the right side of the button. Turn the ignition key to position 0.

Deactivate the code:

When you are asked to enter the code – ignition key in position 1 or 2:

▷ Enter the code at the function buttons.



Press the right side of the button.

After the code has been entered correctly and confirmed with the SET button, the time display appears.

Computer* in the MID

After three incorrect code entries, or three attempts to start the engine without a code entry, the alarm will sound for 30 seconds on vehicles fitted with an alarm system.

Deactivating the alarm in an emergency:

If you have forgotten the code, proceed as follows:

1. Disconnect the battery, wait approx. 2 minutes, then reconnect it. Note that on vehicles with an alarm system, the alarm will sound
2. Set the ignition key to position 1: The time display will count down for the next ten minutes
3. After ten minutes, start the engine.

 If the code becomes available again in the meantime, it can be entered during the waiting period after pressing the CODE button. ◀

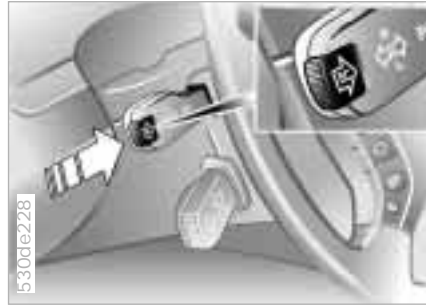

Remote control

The button on the turn signal indicator lever can be used to select the items of computer information which are to be displayed.

To do this, press:

- ▷ the button on the lever until PROG shows on the display
- ▷ the MID buttons in the order in which you wish the information to be displayed.

Each time an entry is stored, the program number appears on the display.

To terminate the selection procedure:



Press the right side of the button.

To have all the available information displayed, press

- ▷ the button on the lever until the display shows PROG
- ▷ the SET button.

To obtain individual items of information, press the button in briefly as often as necessary.

The concept

PDC provides extra safety and convenience during parking maneuvers by providing an acoustic signal to indicate the distance between your front and rear bumpers and the nearest object. To do this, four ultrasonic sensors in the front and rear bumpers each measure the distance to the nearest object. The detection range of the front sensors and the two sensors located at the ends of the rear bumper is approx. 2 ft/60 cm, while the rear center sensors can detect objects to a distance of approx. 5 ft/1.50 m.

 PDC is a parking aid which registers objects when approaching slowly, as is the case during usual parking maneuvers. Avoid approaching objects too fast, otherwise the system may give warning of physical obstacles too late. ◀

Automatic function

The system starts to operate automatically approx. one second after you select reverse or move the selector lever into the R position with the ignition key in position 2.

 Wait for this brief period before you start reversing. ◀

**Manual activation**

Press the button; the indicator lamp comes on.

Manual deactivation

Press the button again; the indicator lamp goes out.

Automatic deactivation

After driving a distance of more than approx. 160 ft/50 m or exceeding a speed of approx. 20 mph/30 km/h, the system switches off and the indicator lamp goes out. Switch the system on again as required.

Acoustical signals

The distance from an object is indicated in front with a higher intermittent tone, and at the rear with a lower intermittent tone. As the distance between vehicle and object decreases, the intervals between the tones become shorter. A continuous tone indicates the presence of an object less than approx. 1 ft/30 cm away.

The warning signal is canceled after approx. 3 seconds if you are moving parallel to a wall.

If there is a malfunction of the system: The indicator lamp flashes and a short steady signal tone is sounded

- ▷ if you activate PDC with the button
- ▷ when you select reverse for the first time after switching on the ignition
- ▷ if a malfunction occurs while the PDC system is active.

Switch the system off and have the cause of the malfunction corrected by your BMW Sports Activity Vehicle center.



The PDC system does not remove the driver's personal responsibility for evaluating the distance between the vehicle and any objects. Even when sensors are involved, there is a blind spot in which objects cannot be detected. This applies especially in those cases where the system approaches the physical constraints of ultrasonic measurement, as occurs with tow bars and trailer couplings, and in the vicinity of thin or wedge-shaped objects. Similarly, low objects that have already been detected - e.g. a curbstone - may disappear out of the range of the sensors before a continuous tone is emitted.

Loud sources of sound, inside and outside the vehicle, could drown out the PDC signal tone. ◀



Keep the sensors clean and free of ice or snow in order to ensure that they continue to operate effectively. Do not apply high pressure spray to the sensors for a prolonged period of time. Maintain an adequate distance of more than 4 in/10 cm. ◀

The concept

DSC maintains vehicle stability, even in critical driving situations.

The system optimizes vehicle stability during acceleration and when starting from a full stop, as well as optimizing traction. In addition, it recognizes unstable vehicle conditions, such as understeering or oversteering, and, as far as is possible within the laws of physics, keeps the vehicle on a steady course by adapting the rpms and brake applications to the individual wheels.

The system starts up automatically each time you start the engine.

Indicator lamp



The indicator lamp in the instrument cluster goes out shortly after you switch on the ignition, refer to page 21.

Indicator lamp flashes:

The system is active and governs drive and braking force.

If the indicator lamp fails to go out after the engine is started, or comes on during normal driving and stays on:

The system is either defective or was switched off with the button: the stabilizing applications described to the left are no longer available. The vehicle will remain completely operational, however, without DSC.

Consult your BMW Sports Activity Vehicle center to have the system repaired.



To switch the system off

Press the button; the indicator lamp comes on and stays on.

Traction intervention remains active; that is, braking intervention will continue.

In the following exceptional circumstances, it may be effective to switch off the DSC for a short period:

- ▷ When rocking the vehicle or starting off in deep snow or on loose surfaces
- ▷ On sandy road surfaces
- ▷ On poor surfaces with deep ruts
- ▷ If the wheels churn on muddy surfaces
- ▷ When driving with snow chains.



As a result of the traction intervention, the brakes may be subjected to additional loads when the system is switched off. For this reason, it is possible that the braking intervention will be disabled automatically for a brief period in order to limit brake temperature.

To maintain vehicle stability, always drive with the system switched on when possible. ◀

To switch the system on again

Press the button again; the indicator lamp goes out.



The laws of physics cannot be repealed, even with DSC. An appropriate driving style always remains the responsibility of the driver. We therefore urge you to avoid using the additional safety margin of the system as an excuse for taking risks. Do not make any modifications to the DSC system. Service procedures on the system are to be performed by authorized technicians only. ◀

Dynamic Brake Control DBC

DBC is an integral component of the DSC system.

The system responds to sudden, high-intensity applications of force to the brake pedal by automatically braking the vehicle with maximum boost to achieve the shortest-possible braking distances during panic stops. This system exploits all the benefits of ABS.

Do not reduce the pressure exerted against the brake pedal until the braking maneuver has been completed. DBC is deactivated when you release the brake pedal.

Hill Descent Control HDC

The concept

HDC is a system for driving downhill in steep terrain. This system reduces vehicle speed on steep downhill gradients, thus allowing you to maintain control of your BMW under these conditions.

The vehicle moves at slightly more than walking speed without active intervention from the driver.

HDC is available for activation at vehicle speeds below approx. 20 mph/ 35 km/h. When driving down steep hills with a speed below approx. 20 mph/ 35 km/h, the vehicle reduces speed automatically down to slightly more than walking speed (approx. 5 mph/ 8 km/h) and then maintains this speed at a constant.

You can use the accelerator or brakes to vary this automatically controlled speed within a range extending from approx. 3 mph/5 km/h to 15 mph/ 25 km/h.

You can specify a target speed within the same range by using the +/- buttons of the cruise control.

HDC is automatically deactivated once vehicle speed again exceeds approx. 35 mph/60 km/h.



To switch the system on

Press the button. The indicator lamp comes on.

The indicator lamp flashes when the brakes are applied automatically.

To switch the system off

Press the button again; the indicator lamp goes out.

HDC is deactivated automatically above a road speed of approx. 35 mph/ 60 km/h and when the ignition is switched off.

To use HDC

With manual transmission:
Use HDC in first gear and in Reverse since the engine's braking effect is diminished in the higher gears.

With automatic transmission:
You can use HDC in every drive position.

In the event of a fault

The indicator lamp goes out in the HDC mode or does not come on when HDC is switched on:

HDC is temporarily not available if brake temperature is too high.



If the DSC indicator lamp also lights up:

There is a fault in the HDC and DSC systems. Have your BMW Sports Activity Vehicle center inspect this system as soon as possible.



The warning lamp for the self-leveling suspension comes on, or the message – SELFLEVEL SUSP.INACT – appears in the Check Control: there is a malfunction in the self-leveling suspension.

Stop and inspect the vehicle. If it is riding significantly lower in the rear than in the front, or if it is sitting at an incline – left rear compared to right rear – consult the nearest BMW Sports Activity Vehicle center. Drive with appropriate caution in the meantime. The vehicle has reduced ground clearance or driving comfort is noticeably reduced.

Even if the attitude of the vehicle is normal, you should consult the nearest BMW Sports Activity Vehicle center if the warning lamp indicates a system malfunction.

The concept

Your vehicle is equipped with 2-axle self-leveling suspension acting on both the front and rear suspension. This system combines automatic self-leveling, which compensates for variations in front-to-rear load-distribution patterns, with a selection feature allowing drivers to choose from among several ride-height options.

You may choose from among the following ride heights:

- ▷ Standard
The standard setting is intended for most operating conditions, including trailer towing
- ▷ Off-Road
Higher ride height for increased ground clearance
- ▷ Access
Lowers vehicle for more convenient cargo handling or easier passenger ingress and exits

Changes in ride height are initiated either manually, using the control button, refer to page 95, or automatically in response to specific speeds. When the ride height is selected manually, the driver has the additional option of revising the ride-height selection by entering a new command during the adjustment process.

When the vehicle is stationary, the system executes ride-height changes in both directions (up and down) whenever the doors are closed. The tailgate/liftgate may be open. The system raises the vehicle only when the engine is running.

The system's automatic self-leveling feature automatically compensates for variations in the vehicle's load.



Frequent changes in ride height initiated at short intervals can overheat the compressor, causing the system to briefly suspend active operation. ◀

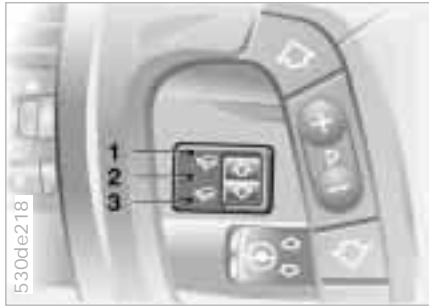

When the suspension reaches the new ride height the flashing LED reverts to continuous operation, and the LED for the earlier level goes out

- ▷ LED for current ride height flashes for roughly 3 seconds when you press the button: change in ride height is not possible.



Ride-height display

- 1 Off-Road
- 2 Standard
- 3 Access

The LEDs not only show the current ride height, but also indicate changes:

- ▷ LED on: indicates the vehicle's current ride height
- ▷ Ride-height LED flashes while the LED for the earlier level remains on: the ride height is being adjusted to a new level, either automatically or in response to driver input at the button.

Raising

Available only when the engine is running.

From Standard to Off-Road:

Press button 1 while traveling at a speed of less than approx. 30 mph/ 50 km/h.

From Access to Standard:

- ▷ Press button 1 or
- ▷ The setting automatically reverts to the standard setting once the vehicle exceeds a speed of roughly 20 mph/ 35 km/h.

96 2-axle self-leveling suspension*

Lowering

Available with ignition key in position 2.

From Standard to Access:

1. Press button 2 while traveling at less than approx. 50 mph/80 km/h. The system enters its preselection mode. The preselection mode is canceled
 - ▷ by pressing button 1
 - ▷ automatically once the vehicle exceeds a speed of approx. 50 mph/80 km/h or roughly 60 seconds after button 2 is pressed
2. Reduce speed to below approx. 15 mph/25 km/h within roughly 60 seconds after pressing button 2.

 When you press button 2 at speeds below approx. 15 mph/25 km/h the system automatically lowers the vehicle to the Access level. ◀

From Off-Road to Standard:

- ▷ Press button 2 or
- ▷ automatically once you exceed a speed of approx. 30 mph/50 km/h.

The concept

RDC monitors the tire pressures at all four tires, even when the vehicle is moving. The system provides an alert whenever the inflation pressure drops significantly below the specified pressure in one or more tires.

In order for the system to learn the correct tire inflation pressure, check the inflation pressures in all tires, refer to the table on page 27 and make any necessary corrections. Then activate the system.



This indicator lamp in the instrument cluster or the Check Control will inform you if the tire pressure is different from the learned values.



To switch the system on

1. Turn the ignition key to position 2, do not start the engine
2. Maintain pressure on the button until the yellow indicator lamp in the instrument cluster comes on for several seconds or the message – TIRE PRESSURE SET – appears in the Check Control
3. After you have driven for a few minutes, the RDC will import the current inflation pressure in the tires as the reference values which the system will monitor.

You will only have to repeat this procedure if the tire inflation pressure must be corrected. Otherwise, the RDC functions automatically when the ignition key is in position 2, and thus operates whenever the vehicle is driven.

Loss of tire pressure

If, after a certain period of time, the inflation pressure has gone down significantly, which is normal for any tire, the yellow indicator lamp comes on or the message – CHECK TIRE PRESSURE – appears in the Check Control.

This alerts you that you should have the tires inflated to the specified pressures as soon as possible.



If you are prompted to check the tire pressure shortly after a correction has been made, this indicates that the corrected values were not accurate. Please check the inflation pressure again and make corrections according to the inflation pressure table. After that reactivate the system. ◀

Flat tire

If there is a tire failure with a loss of inflation pressure, the red indicator lamp comes on or the message – TIRE LOW/FLAT – appears in the Check Control. In addition, an acoustic signal sounds.

If this occurs, reduce vehicle speed immediately and stop the vehicle in a safe location. Avoid hard brake applications. Do not oversteer. Replace the flat tire.



The spare tire which is available in your vehicle as standard equipment is equipped with the electronics required for RDC and, following activation of the system, is also monitored after it is mounted. ◀



RDC cannot alert you to severe and sudden tire damage caused by external factors. ◀



Have the tires changed at your BMW Sports Activity Vehicle center.

Your BMW Sports Activity Vehicle center has the information needed for working with RDC and is equipped with the necessary special tools. ◀

System malfunction

During the period of the malfunction, the yellow indicator lamp comes on or the message – TIRECONTROL INACTIVE – appears in the Check Control.

You will also see the same message

- ▷ in the event of a system malfunction
 - ▷ if a wheel is mounted without the RDC electronics
 - ▷ if, in addition to the spare tire, additional wheels with RDC electronics are on board
 - ▷ after installation of one or several wheels with an electronics system still unknown to the system.
- It takes a few minutes to learn the new wheel electronics ID numbers after system activation. Only then can RDC detect and report a flat tire.

Please contact your BMW Sports Activity Vehicle center for additional information.

Adaptive brake light

The adaptive brake light provides drivers of following vehicles with an indication of the intensity with which the brakes are being applied in your own vehicle.

The display occurs in two stages:

- ▷ Normal braking:
The brake light units within the tail lamps and the high-mount brake lamp integrated within the rear spoiler both light up with normal intensity
- ▷ Hard braking or braking with ABS active:
The tail lamps also come on, lighting up with the same intensity as the brake lamps to provide a more conspicuous warning.

Parking lamps/Low beams



Parking lamps – side marker lamps

 The front, rear and side vehicle lighting is switched on. You can use the parking lamps for parking. For lighting on one side for parking as an additional feature, refer to page 100.

Low beams

 When the ignition is switched off and the low beams are on, only the parking lamps – side marker lamps – remain on.



Follow me home lamps:
When you activate the headlamp flasher after parking the vehicle and switching off the lamps, the low beams will come on for a brief period. You may also have this function deactivated if you wish. ◀

LIGHTS ON warning

Whenever you open the driver's door, after having turned the ignition key to position 0, you will hear an acoustic signal for a few seconds to remind you that the lamps have not been switched off.

On vehicles with alphanumeric Check Control*:
The reminder is given through the Check Control.

Daytime driving lamps*

The headlamps are automatically switched on for daylight driving at ignition key position 2.

Automatic headlamp control*



When the switch is set to this position the system automatically activates or deactivates the low beams in response to changes in ambient light, e. g. in tunnels, at dusk, as well as rain and snow.



The vehicle's external lamps remain on constantly when you switch on the fog lamps after the headlamps have come on automatically. ◀



Automatic headlamp control cannot serve as a substitute for the driver's judgement in determining when the vehicle lamps should be switched on. For example, the sensors are not able to detect fog. To avoid safety risks, you should respond to these kinds of low-visibility situations by switching the headlamps on manually. ◀



You can have the sensitivity of your vehicle's automatic headlamp control adjusted. ◀



530us216

Turn the rotary dial to adjust the illumination intensity.

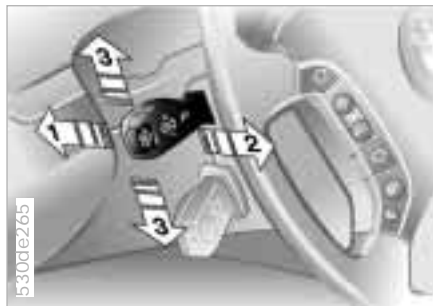

530de265

- 1 High beams – blue indicator lamp
- 2 Headlamp flasher – blue indicator lamp
- 3 Standing lamps

Standing lamps, left or right*

As an additional feature, you can illuminate your vehicle on either side for parking, if you wish to do so:

With the ignition key in position 0, engage the lever in the appropriate turn signal position.



530us210

Fog lamps

 A green indicator lamp appears in the instrument cluster to indicate that the front fog lamps are on.

If the high beams are switched on, the fog lamps go out.

 If the automatic headlamp control is activated, the low beams will automatically be switched on when the front fog lamps are switched on. ◀

Interior lamps

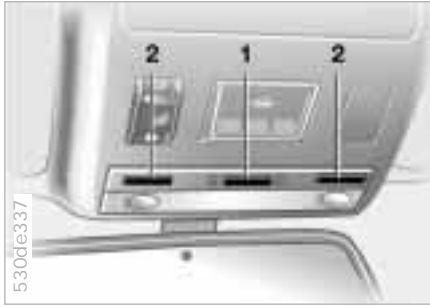

The interior lamps operate automatically.

Switching the interior lamps on and off manually

Press the button briefly.

If you want the interior lamps to remain off all the time, press and hold the button for approx. 3 seconds.

Press the button briefly to revert to normal operation.

The button for the interior lamps in the rear passenger area only switches these lamps on and off.

Front reading lamps*

Switched on and off with the button 2 next to each lamp.



Rear reading lamps*

Switched on and off with the button next to each lamp, refer to arrows.

Footwell and cargo area lamps

The lamps are controlled in the same manner as the front interior lamps.

Front area lighting*

This lighting system in the two exterior mirrors illuminates the ground in the area near the two front doors. It is also controlled in the same manner as the front interior lamps, but it does not function while the vehicle is moving.

 In order to prevent battery discharge, all of the lamps in the vehicle are switched off automatically approx. 15 minutes after the ignition key is turned to position 0. ◀

102 Air conditioner

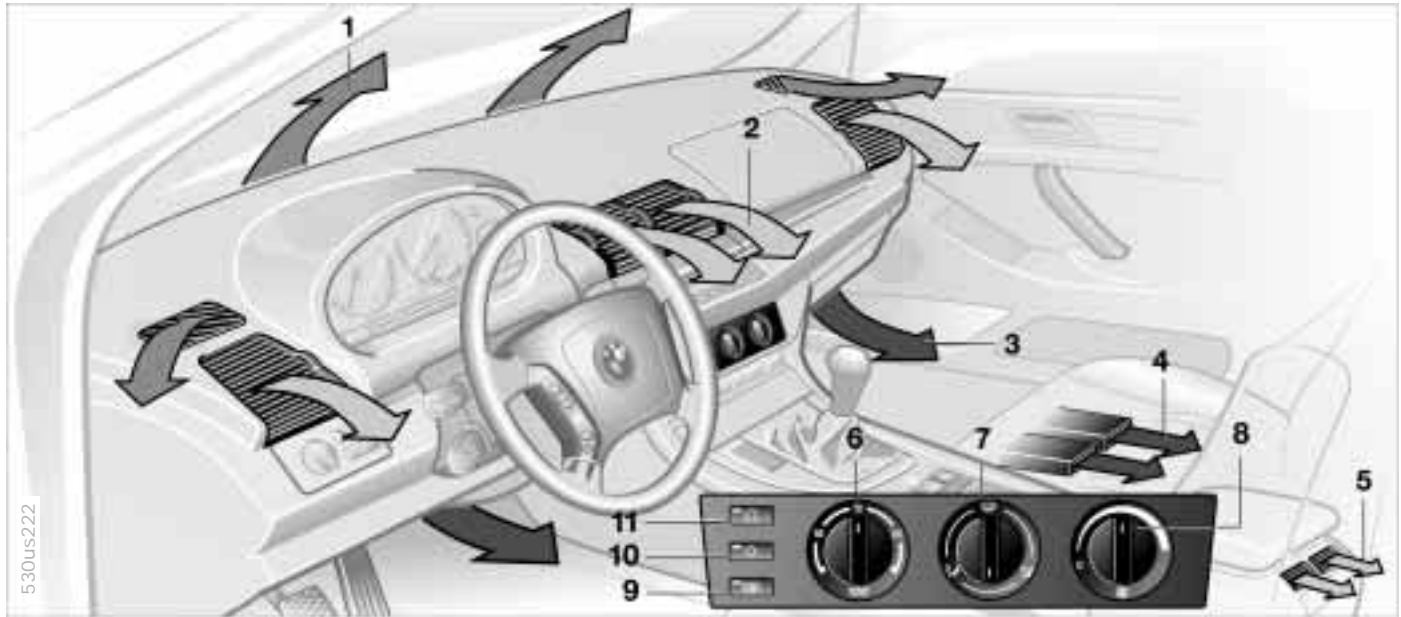

1 Airflow directed toward the windshield and side windows

2 Airflow for the upper body [104](#)

3 Front footwell ventilation

4 Rear footwell ventilation

5 Airflow for the upper body in the rear seat [104](#)

6 Temperature [103](#)

7 Air distribution [103](#)

8 Air supply [103](#)

9 Rear window defroster [103](#)

10 Air conditioning [103](#)

11 Recirculated-air mode [103](#)

Air conditioner





Temperature



The graduations on the dial provide general reference values for the interior temperature. We recommend +70 °F/+22 °C as a comfortable setting. When you start the vehicle, the system adjusts the air to the selected temperature as quickly as possible, and then maintains that temperature constantly.

Air distribution



You can direct air to flow onto the windows , toward the upper body  and into the footwell . All intermediate settings are possible. In the  setting, there is a low flow of air onto the windows to keep them free of condensation.

Air supply



You can adjust the air supply through an infinitely-variable range. The heating and ventilation become more and more effective as the air supply settings are increased. In the 0 setting, the blower and climate control are switched off and the outside air supply is blocked.

Rear window defroster



When the rear window defroster is activated, the indicator lamp comes on. The rear window defroster switches off automatically.

Air conditioning



The air is cooled and dehumidified and – depending on the temperature setting – warmed again. Depending on the weather, the windshield may fog over briefly when the engine is started. You can reduce condensation forming on the windows by switching on the air conditioning.



During air conditioning condensation forms, which then exits under the vehicle. Traces of condensed water of this kind are thus normal. ◀

Recirculated-air mode



You can respond to unpleasant odors outside the vehicle by temporarily switching off the outside air supply. The system then recirculates the air currently within the vehicle.

If you have a steering wheel with multi-function buttons with the button for the recirculated-air mode, you can also use this button to switch to the recirculated-air mode, refer to page [23](#).



If the windows fog over in the recirculated-air mode, switch the recirculated-air mode off and increase the air supply as required. ◀



Draft-free ventilation

You can adjust the vent outlets for the upper body area completely for your personal comfort:

- 1 Rotary dials for opening and closing the vent outlets through an infinitely-variable range
- 2 Levers for adjusting airflow direction
- 3 With the rotary dial you can adjust the temperature of the incoming air:
 - ▷ Turn toward blue – colder
 - ▷ Turn toward red – warmer.



Rear passenger area ventilation

- 1 Rotary dial for opening and closing the vent outlets through an infinitely-variable range
- 2 Levers for adjusting airflow direction. The air that flows out here is somewhat cooler than the air delivered to the footwell.

Particle filter

The particle filter removes dust and pollen from the incoming air. It is replaced by your BMW Sports Activity Vehicle center during regular maintenance. A substantial reduction in air supply indicates that the filter must be replaced before normal maintenance.

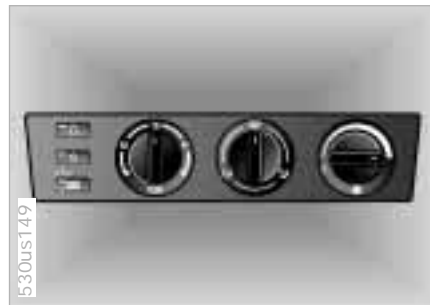

To defrost windows and remove condensation

1. You can specify an interior temperature that is comfortable for you with the rotary temperature dial. A good starting point is +70 °F/+22 °C
2. Set the air distribution rotary dial to 
3. Set the blower/air supply rotary dial completely to the right
4. Close the vent outlets in the rear seating area
5. Switch on the rear window defroster to defrost the rear window.

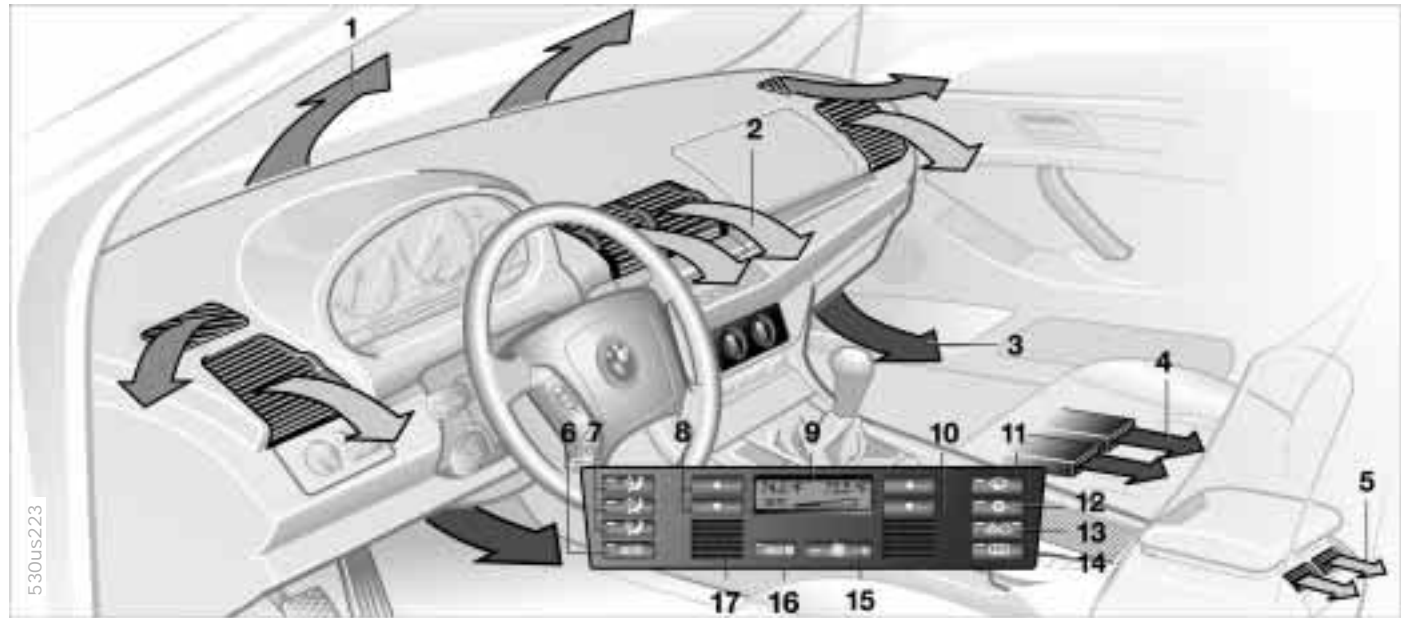

1 Airflow directed toward the windshield and side windows

2 Airflow for the upper body [109](#)

3 Front footwell ventilation

4 Rear footwell ventilation

5 Airflow for the upper body in the rear seat [109](#)

6 Automatic air distribution and air supply [107](#)

7 Individual air distribution [107](#)

8 Temperature control - left-hand side [107](#)

9 Display for temperature and air supply [107](#)

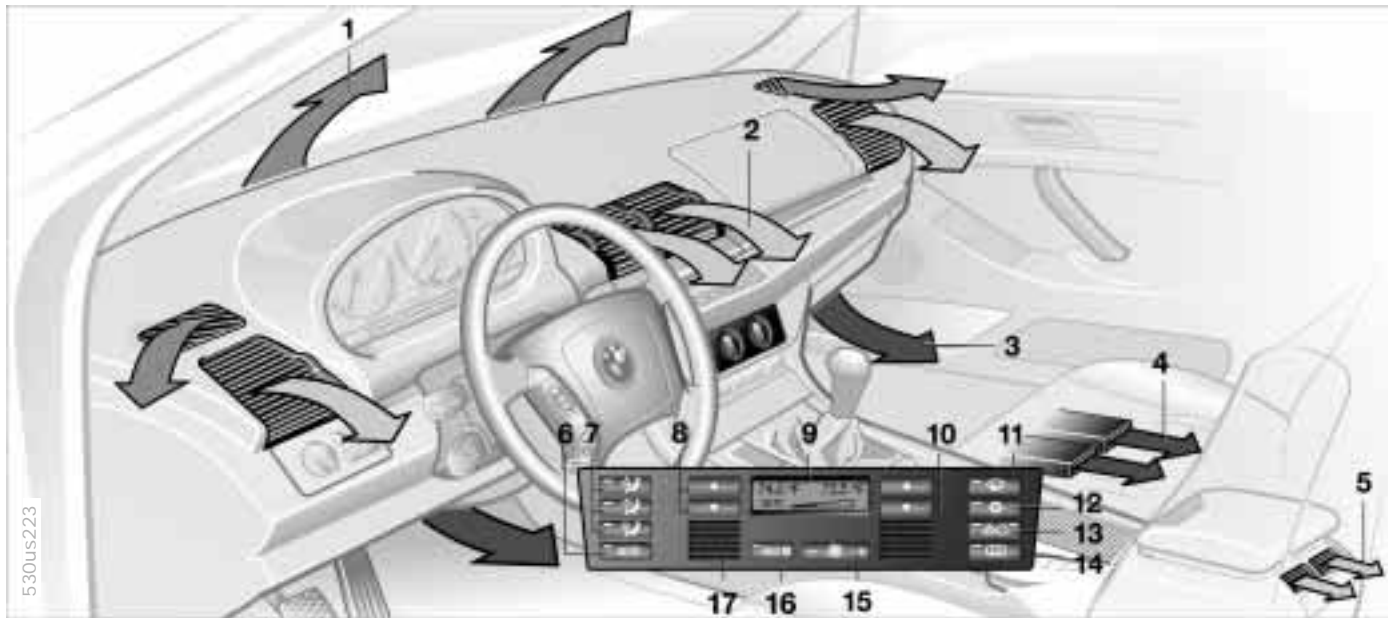

530us223

10 Temperature control – right-hand side [107](#)

11 To defrost windows and remove condensation [108](#)

12 Air conditioning [108](#)

13 Automatic recirculated-air control (AUC) [108](#)

14 Rear window defroster [108](#)

15 Air supply [107](#)

16 Maximum cooling [108](#) or using up residual heat [109](#)

17 Air grille for interior temperature sensor – please keep clear and unobstructed

Tips for pleasant driving

Use the automatic system; that is press AUTO button 6. Select an interior temperature that is comfortable for you. Detailed setting options are described for you in the following section.



Your BMW center can program the settings of your vehicle in such a manner that, when you unlock the vehicle with your individualized key, your own personalized setting for the automatic climate control is initiated. ◀



Automatic air distribution



The AUTO program assumes the adjustment of the air distribution and the air supply for you and also adapts the temperature to external influences – summer, winter – to meet preferences you can specify.

Individual air distribution



You can cancel the AUTO program by selecting specific air distribution patterns for your personal comfort, the automatic air supply remains in operation. You can direct air to flow onto the windows , toward the upper body , and into the footwell . You can reactivate the automatic air distribution mode by selecting the AUTO button.

Temperature



You can make individual temperature settings on the driver's side or the front passenger side. Your settings will be shown in the display 9. The displayed temperatures are reference values for the interior temperature. We recommend +70 °F / +22 °C as a comfortable setting, whether the air conditioner is operating or not. When you start the vehicle, this system ensures that the selected temperature is achieved as quickly as possible. It then maintains this temperature, regardless of the season.

To change the units of measurement – °C/°F – of the display, refer to page 73 or .

Air supply



In the AUTO program, the air supply is controlled automatically. AUTO will appear in the display 9, refer to the overview on page 105. Press the left or right side of the button to vary the air supply. When your setting is displayed by bars, the automatic air supply is switched off. Automatic air distribution maintains its setting. You can reactivate the automatic air supply by pressing the AUTO button.

When you press the left side of the button during operation at minimum blower speed all displays are canceled: the blower, heating and air conditioner are switched off. The outside air supply is closed. You can switch the system back on by pressing any button of the automatic climate control, except the MAX button 16.

To defrost windows and remove condensation



This program quickly removes ice and condensation from the windshield and the side windows.

Air conditioning

The air is cooled and dehumidified and – depending on the temperature setting – warmed again. Depending on the weather, the windshield may fog over briefly when the engine is started. You can reduce condensation forming on the windows by switching on the air conditioning.



During air conditioning condensation forms, which then exits under the vehicle. Traces of condensed water of this kind are thus normal. ◀

Maximum cooling

You will get maximum cooling capacity using this program if the engine is running and the outside temperature is above approx. +41 °F/+5 °C.

The temperature display 9 jumps to +60 °F/+16 °C, the system switches over to the recirculated-air mode, and the air streams out of the ventilation grill with the maximum air supply. That is why you need to keep these open if you select this program.

Automatic recirculated-air control AUC

If there are unpleasant odors or pollutants in the outside air, you can temporarily block the air supply from the outside. The system then recirculates the air currently within the vehicle. Press the button repeatedly to run through the following control sequence

- ▷ Indicator lamps off: outside air supply operational
- ▷ Left-hand indicator lamp on – AUC mode: the system recognizes pollutants in the outside air and blocks the flow of air when necessary. The system then recirculates the air currently within the vehicle. Depending on the air quality, the automatic system then switches back and forth between outside air supply and recirculation of the air within the vehicle
- ▷ Right-hand indicator lamp on: the outside air supply into the vehicle is completely blocked. The system then recirculates the air currently within the vehicle.

If you have a steering wheel with multi-function buttons with the button for recirculated-air mode, refer to page 23, you can also use this button to switch between Off and the recirculated-air mode or AUC and the recirculated-air mode.



If the windows fog over in the recirculated-air mode, switch the recirculated-air mode off and increase the air supply as required. ◀

Rear window defroster

When the rear window defroster is activated, the indicator lamp comes on. The rear window defroster switches off automatically.

Automatic climate control*

Residual heat mode



The heat which is stored in the engine is utilized for heating the interior when the engine has been switched off (while waiting at a railroad crossing, for instance). In ignition key position 1, you can alter the settings of the automatic climate control. With the ignition key in position 0, the system automatically directs heated air to the windshield, side windows and footwells.



This function may be activated when the outside temperature is below approx. 59 °F/15 °C, the engine is at operating temperature, and the battery is adequately charged. The LED on the button will light up when all conditions have been met. ◀



Draft-free ventilation

You can adjust the vent outlets for the upper body area to select the optimum airflow rates and directions for your personal comfort:

- 1 Rotary dials for opening and closing the vent outlets through an infinitely-variable range
- 2 Selector levers for airflow direction
- 3 With the rotary dial you can adjust the temperature of the incoming air.
 - ▷ Turn toward blue – colder
 - ▷ Turn toward red – warmer.



Rear passenger area climate control

- 1 Air supply
- 2 Temperature
- 3 Adjusting the direction of the airflow



Air supply

0 Blower off

I Maximum blower speed

You can adjust the air supply for the vent outlets through an infinitely-variable range between the 0 and I settings.

In the 0 setting, the blower is switched off and the supply of air through the vent outlets is blocked.

Individual adjustments on the front-seat control elements influence the air supply for rear passenger area climate control.



Temperature

Passengers in the rear seating area can adjust their own temperature for the vent outlets:

- ▷ Turn toward blue – colder
- ▷ Turn toward red – warmer

When you start the vehicle, this system ensures that the selected temperature is achieved as quickly as possible. It then maintains this temperature, regardless of the season.

 A temperature setting is only possible when the blower is switched on, not in the 0 setting. ◀

Particle filter, activated-charcoal filter

The particle filter removes dust and pollen from the incoming air. The activated-charcoal filter provides additional protection by filtering gaseous pollutants from the outside air. Your BMW Sports Activity Vehicle center replaces this combined filter as a standard part of your scheduled maintenance. A substantial reduction in air supply indicates that the filter must be replaced before normal maintenance.

Roller sun blinds*

Roller sun blinds for rear side windows*

Use the strap to pull out the blinds, then hook them in the provided attachment.



With roller sun blinds attached, do not open the windows during travel. The blinds may otherwise be damaged by the wind. ◀

Independent ventilation system*

You can use this system to ventilate the interior and lower its temperature, using the blower of the independent ventilation or of the automatic climate control.

The independent ventilation system is operated via the Multi-Information display MID, refer to page 84 or via the onboard computer, refer to the separate Owner's Manual.

You can set two different times for the system to start; it will remain active for 30 minutes. You can also switch it on and off directly. Since the system uses a substantial amount of electrical current, you should refrain from switching it on twice in succession without allowing the battery to be recharged in normal operation between use.

When a preselected activation time is set, the independent ventilation system is operational at outside temperatures above +60 °F / +16 °C, or by direct switch activation.

The air emerges via the vent outlets for the upper body. Therefore, the vent outlets must be open for the system to operate.

The concept

The BMW Universal Transmitter replaces up to three hand-held transmitters of different devices such as garage door openers, alarm systems, or door locking systems. The BMW Universal Transmitter recognizes and learns the transmitted signal of each of the original hand-held transmitters.

The signal of an original hand-held transmitter can be programmed on one of the three channel keys. Following that, each of the devices can be actuated with the appropriately-programmed channel key. The indicator lamp flashes to confirm transmission of the signal.

If the vehicle is sold, the memory of the channel keys should be cleared as described on page [114](#).



During programming and before every remote actuation of a programmed device by the BMW Universal Transmitter, check to be sure that there are no persons, animals or objects within the actuation range of the device in order to prevent possible injuries or damage. Also, comply with the safety precautions of the original hand-held transmitter. ◀



To Canadian residents:
During programming, your hand-held transmitter may automatically stop transmitting after two seconds. This may not be long enough to program the BMW Universal Transmitter. If you are programming from one of these hand-held transmitters, the Universal Transmitter's light may begin to flash in a series of double-blinks. If this occurs, continue to hold the button of the Universal Transmitter while you reactivate your hand-held transmitter. You may have to repeat this function several times while programming. ◀



Before programming, read the User information section on page [114](#). ◀

Original hand-held transmitter



If this symbol is present on the packaging or in the instructions of the original hand-held transmitter, it may be assumed that this hand-held transmitter is compatible with the BMW Universal Transmitter.

BMW Universal Transmitter

Checking for the conversion code

To determine whether the original hand-held transmitter is provided with a conversion-code system, you may either read the instructions for the original hand-held transmitter or program a channel key as described on the next page – left-hand column under Programming.

Then press and hold the programmed channel key of the BMW Universal Transmitter. If the indicator lamp of the BMW Universal Transmitter flashes for two seconds and then comes on steadily, the original hand-held transmitter is provided with a conversion-code system. With a conversion-code system, program the channel keys as described on the next page – right-hand column under Programming a hand-held transmitter with conversion code.

 If you have additional questions, please consult your BMW Sports Activity Vehicle center or call 1-800-355-3515. You can also visit this website: www.bmwusa.com.



Programming

- 1 Channel keys
- 2 Indicator lamp
- 3 Receiver for programming



Read and comply with the safety precautions on the previous page. ◀

1. Turn the ignition key to position 2
2. For initial use:
Press and hold both outside keys 1 until the indicator lamp 2 flashes, and then release them. The three channel keys are cleared

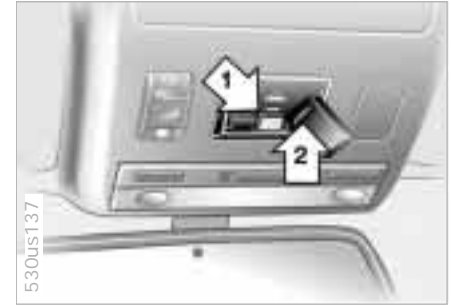

3. Hold the original hand-held transmitter toward the receiver 3 a maximum of 2 in/5 cm away
4. Press the transmission key of the original hand-held transmitter, refer to arrow 2, and the desired channel key of the Integrated BMW Universal Transmitter, refer to arrow 1, simultaneously. Release both keys as soon as the indicator lamp flashes rapidly
5. To program other original hand-held transmitters, repeat steps 3 and 4.

The corresponding channel key is now programmed with the signal of the original hand-held transmitter.

Programming a hand-held transmitter with conversion code

 Read and comply with the safety precautions on page 112. ◀

When programming the BMW Universal Transmitter, consult the instructions for the specific device.

For using the BMW Universal Transmitter with a conversion-code system, note the following supplemental programming instructions:

 A second person facilitates programming of the BMW Universal Transmitter. ◀

1. Program the BMW Universal Transmitter as described previously under Programming
2. Press and hold the programming key on the receiver of the device for approx. two seconds until the programming lamp on the device comes on
3. Press the desired channel key of the BMW Universal Transmitter three times.

 If you have additional questions, please consult your BMW Sports Activity Vehicle center. ◀

Clearing the channel keys

 Read and comply with the safety precautions on page 112. ◀

The memory of individual channel keys cannot be cleared. However, the three channel keys can be cleared together as follows:

- ▷ Press and hold both outside keys of the BMW Universal Transmitter until the indicator lamp flashes, and then release them.

All of the channel keys are cleared.

User information

Do not use this BMW Universal Transmitter with any garage door opener that lacks safety stop and reverse features as required by federal safety standards, this includes any garage door opener model manufactured before April 1st, 1982.

This device complies with Section 15 of the FCC Rules. Operation is subject to the following two conditions: as defined in the regulations, this device must not emit harmful interference, and must be shielded against interference from external sources to prevent unauthorized or inadvertent activation.

Glove compartment



To lock

Use one of the master keys. A master key is also required for unlocking.

 If you turn over only your door and ignition key for valet parking, for example, refer to page 30, access to the glove compartment is not possible. ◀

Rechargeable flashlight*

Located on the left-hand side of the glove compartment. Features integral overload-protection, so it can be left in its holder continuously.

 To avoid completely discharging and possibly damaging the lamp, always ensure that it is switched off before inserting it in the socket. ◀

To open

Pull the handle. The lamp inside the glove compartment comes on.

To close

Fold the cover up.

 To prevent injury in the event of an accident, close the glove compartment immediately after use. ◀



You will find two storage compartments in the armrest between the front seats.

To open the top compartment:
Press the button, refer to arrow 1.

You will find a cellular phone* in this compartment.

To move the armrest or open the lower compartment:

Pull the handle, refer to arrow 2.

In this compartment, you will find a coin tray and a storage compartment* for cassettes or CDs.

You will find additional storage compartments in all of the doors as well as on the backrests of the front seats.



Hands-free system

On vehicles with telephone preparation*, the hands-free microphone is positioned in the headliner.

For further information on the cellular phone, refer to the Telephone Owner's Manual.



Front

Below the sliding cover, refer to illustration.

Remove the insert which is a compartment for storing pens.

Beverage holder



Rear

At the end of the center console under the lighter.

Press briefly to open; push back inward to close.

Glasses compartment



Press the button to open; fold upward to close.

Ashtray, front



To empty

Press the edge of the lid, refer to arrow: the ashtray moves up and can be removed.

Cigarette lighter, front

Press the lighter 1 in.

The lighter can be removed as soon as it retracts.

 Hold or touch the hot cigarette lighter by the knob only. Holding or touching it in other areas could result in burns.

The cigarette lighter remains operational when the ignition key has been removed. For this reason, do not leave unsupervised children in the vehicle. ◀

118 Ashtray, front

Cigarette lighter socket

This socket is suitable for attaching power supplies for flashlights, car vacuum cleaners and other appliances up to a rating of approx. 200 watts at 12 volts. Avoid damage to the socket caused by inserting plugs of a different shape or size.

You will find additional power outlets in the cargo area, refer to page [124](#).

Ashtray, rear



To empty

Remove the insert tray.

Cigarette lighter, rear



Press the lighter in.

The lighter can be removed as soon as it retracts.



Hold or touch the hot cigarette lighter by the knob only. Holding or touching it in other areas could result in burns.

The cigarette lighter remains operational when the ignition key has been removed. For this reason, do not leave unsupervised children in the vehicle. ◀

Ski bag*

The ski bag allows the safe and clean transport of up to 4 pairs of standard skis or up to two snowboards.

With the length of the ski bag and the additional space in the cargo area, you can store skis with a length of up to 6.8 ft/2.1 m. Because of the tapered shape of the bag, the ski bag can only accommodate two pairs of skis with a length of 6.8 ft/2.1 m.



Loading

1. Fold the center armrest outward.
Loosen the trim from the upper Velcro® fastener and place it on the armrest
2. Press button 1 downward and swing the cover forward
3. Press button 2: the cover in the cargo area is unlocked.
Together with the pull-out cargo floor, refer to page 124: pull the floor out, release the cover and slide the floor back in – the floor then conceals the cover
4. Extend the ski bag between the front seats. The zipper provides convenient access to the inside of the bag, or can also be left open to promote drying.

To store the ski bag, perform the above steps in reverse sequence.



Securing the load

-  Secure the bag's contents by tightening down the retaining strap at the buckle. ◀

Please be sure that the skis are clean before loading them into the bag. Be careful to avoid damage from sharp edges.

-  If the cover in the cargo area is concealed by the pull-out cargo floor, do not fold the larger rear backrest down. If you do so, it will damage the cover. ◀

Cargo area



Fold the rear backrests down

Reach into the recess and pull forward, refer to arrow.

-  When you fold back the backrest, be sure that the catch engages securely. The red warning indicator disappears in the recess when the catch is engaged. The center safety belt can be retracted only when the larger backrest is engaged. ◀



Cargo area cover

Pull the cover out by the handle and hook it in the rear holders.

You can carry light objects such as articles of clothing on the cover.

 Do not place heavy or hard objects on the cover. If you do so, they could already pose a danger to vehicle occupants during braking or evasive maneuvers. ◀

Before you slide it back into position, place the grip in the rear fold of the cover.



When the cover is pulled out, it can be opened behind the rear-seat backrest to gain access to the cargo area from the rear seats during a trip, for example. For removing the cover, refer to the next column.

Removing the cover

1. Use both hands to press the cover together on both sides and slide it forward, refer to arrow 1
2. Lift the cover upward from the rear on both sides, refer to arrow 2, and remove it.

Installation

Slide the cover into the retainers on both sides and then press it down at the rear until it engages.

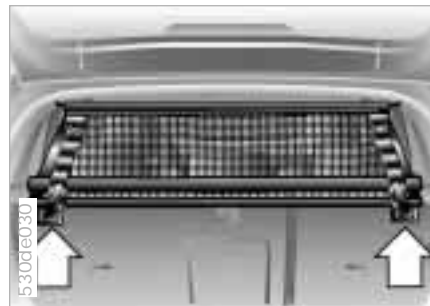
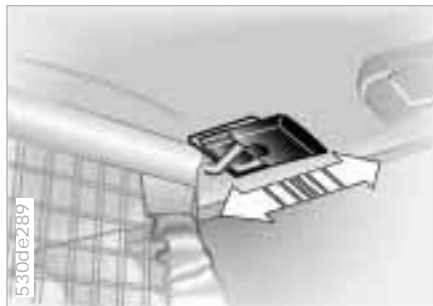
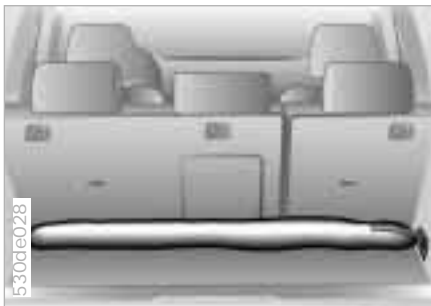

Partition net*

1. Remove the bag with the partition net from the retainer by releasing the hooks from the lashing eyes on both sides
2. Remove the partition net from the bag and unroll it half way

 Note how the bag with the partition net is secured in the vehicle and how the partition net is rolled up and stored in the bag so that you can return everything to its place after use. If your vehicle is equipped with a pull-out cargo floor be sure to read the note on page [124](#). ◀

3. Slide back the covers on the retainers for the partition net on both sides of the roof, refer to arrow
4. Insert the curved ends of the partition net rod in the retainers on both sides
5. Now you can slide the covers toward the front again, refer to arrow

6. Attach the hooks on the bottom of the partition net into the eyes on both sides

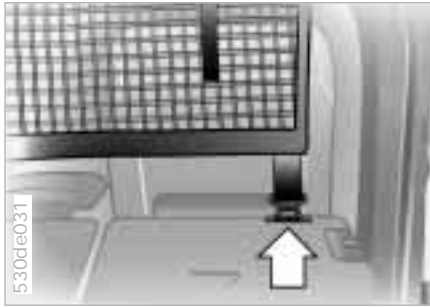

7. When the rear backrests are folded down, you can open the Velcro® strips, completely unroll the partition net, insert it in the front retainers on the roof and attach the three hooks into the eyes. The illustration shows securing at the bottom right as an example.



Side covers

Pull the handle to open the side covers.

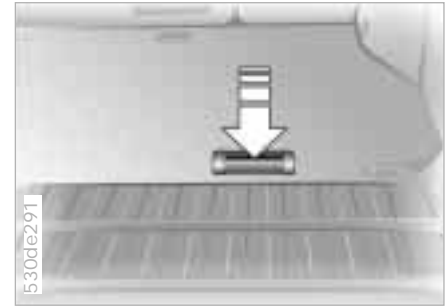

Floor cover

To access the spare wheel.

To release: press the recess in the handle, refer to arrow, and raise the cover with the handle.



Fold the floor cover up

Lift up the black retainer on the lower side of the floor cover and hook it into the upper frame of the liftgate cutout.

Before you fold the floor cover down, return the retainer to its original position.



Power outlets

When you fold the cover caps up, you have access to additional power outlets.

You can use the power outlets for flashlights, car vacuum cleaners or other automotive appliances with up to approx. 200 watts at 12 volts. Avoid damage to the socket caused by inserting plugs of a different shape or size.

Refer also to page [118](#).

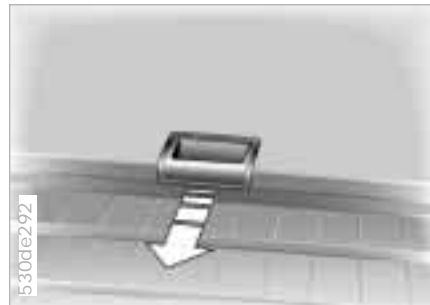

Pull-out cargo floor*

To release, pull the handle recess upward. Then pull the floor out.



Do not drive when the cargo floor is pulled out.

Do not release the cargo floor on steep grades. If you do, it could extend automatically and cause personal injuries. A load which is not properly secured could begin to slide if the floor extends automatically and then drop to the ground as a result of the rapid braking of the cargo floor at the limit stop. ◀

Cargo area

When it is extended, you can load the cargo floor:

- ▷ With up to 990 lbs/450 kg, distributed evenly across the entire surface
- ▷ With up to 330 lbs/150 kg on the rear edge.



Do not overload the cargo floor when it is extended. If you do so, it could cause damage.

When you slide the cargo floor back in, do not grasp it on the bottom. If you do so, there is a risk of personal injury. ◀



Raise the cargo floor

For access to the spare wheel or other stored items:

Swing the cargo floor up and secure it with the rod, see detail.



If your vehicle has a partition net: Take the bag with the partition net out of the retainer, refer to page [122](#), before you raise the cargo floor panel. Otherwise, the bag could slide downward. ◀



Stowing cargo

- ▷ Position heavy cargo as far forward as possible – directly behind the backrests – and as low as possible
- ▷ Cover sharp edges and corners
- ▷ Do not pile objects higher than the top edge of the backrest
- ▷ Fasten the partition net, refer to page 122, and ensure that carried items cannot pass through the partition net
- ▷ If you are transporting very heavy loads when the rear seat is not occupied, secure the outer safety belts in the opposite buckles.



Securing the load

- ▷ Secure smaller, light pieces with the retaining straps or a luggage net*, or use elastic straps, refer to page 38
- ▷ For large, heavy pieces, see your BMW Sports Activity Vehicle center for load-securing devices*. The lashing eyes provided at the corners of the cargo area serve for mounting these load-securing devices
- ▷ Read and comply with the information enclosed with the load-securing devices.



Always position and secure the load correctly. If you do not, it can endanger the passengers, e.g. simply during braking or evasive maneuvers. Do not exceed the permissible gross vehicle weight and the permissible axle loads, refer to page 170. If you do, the operating safety of the vehicle is no longer ensured and you are in violation of the law.

Do not carry hard or heavy objects unsecured in the passenger compartment. If you do so, they may be projected through the air, e.g. simply during braking and evasive maneuvers, thus endangering vehicle occupants. ◀



A special rack system is available as an optional extra for your BMW. Please comply with the precautions included with the installation instructions.

Mounting points

Access to the mounting points: To fold up the cover, refer to arrow, please use the tool which is provided with the rack system.

Cargo loading and driving hints

Roof-mounted luggage racks raise the center of gravity of the vehicle when they are loaded. For this reason, they exercise a major effect on the vehicle's handling and steering response.

You should therefore always remember not to exceed the approved roof weight, the approved gross vehicle weight or the axle loads when loading the rack.

You will find the specifications under Technical Data on page [170](#).

Make sure that the load is not too heavy, and attempt to distribute it evenly. Always load the heaviest pieces on the bottom. Be sure that adequate clearance is maintained for raising the sliding/tilt sunroof, and that objects do not project into the opening path of the liftgate.



Always ensure that roof-mounted loads are tightly secured, as loose loads can shift or even fly off the roof, posing a serious hazard for following traffic. ◀

Drive smoothly. Avoid sudden acceleration and braking maneuvers. Take corners gently.



Overview

Controls and features

Operation, maintenance

Owner service procedures

Technical data

Index



Overview

Controls

Maintenance

Repairs

Data

Index

To ensure that your vehicle provides maximum economy throughout a long service life, we request that you observe the following instructions:

Engine and differential

Up to 1,200 miles/2,000 km:

Drive at varying engine speeds and road speeds, but do not exceed 4,500 rpm and the following road speeds during this initial period:

6-cylinder engines: 100 mph/160 km/h

8-cylinder engines: 106 mph/170 km/h

Obey your local and state maximum speed limits.

Refrain from using full throttle and avoid pressing the accelerator beyond the kickdown point.

Once you have driven 1,200 miles/2,000 km, engine and vehicle speeds can gradually be increased.

You should also comply with these break-in procedures should the engine or one of the differentials be replaced later in the course of the vehicle's service life.

Tires

Due to technical factors associated with their manufacture, tires do not achieve their full traction potential until an initial break-in period has elapsed. For this reason, drive with extra care during the initial 200 miles/300 km.

Obey your local and state maximum speed limits.



When the vehicle is operated on wet or slushy roads, a wedge of water may form between the tire and the road surface. This phenomenon is referred to as aquaplaning, or hydroplaning, and can lead to partial or complete loss of traction, vehicle control and braking effectiveness. Reduce your speed on wet roads. ◀

Brake system

Approx. 300 miles/500 km must elapse before the brake pads and rotors achieve the optimal pad-surface and wear patterns required for trouble-free operation and long service life later on.

To break in the separate parking brake drums, apply the parking brake lightly when coasting to a standstill at a traffic signal, for instance, provided that traffic conditions allow you to do so.

To avoid corrosion, repeat this procedure from time to time.



The brake lamps do not light up when the parking brake is applied. Vacuum for the brake system servo unit on your BMW is available only when the engine is running. When you move the vehicle with the engine switched off – when towing, for instance – substantially higher levels of pedal force will be required to brake the vehicle. ◀

Driving your BMW X5

Your BMW is right at home on all roads and byways – even where the pavement ends. It combines permanent four-wheel drive with the agility of a typical passenger vehicle.

On bad roads

When you are driving on bad roads, there are a few points which you should strictly observe – for your own safety, for that of your passengers, and for the safety of the vehicle:

- ▷ Familiarize yourself with the vehicle before you begin driving. Do not take risks with the vehicle under any circumstances
- ▷ Always adapt vehicle speed to road conditions – the steeper and more uneven the road surface is, the slower the vehicle's speed should be
- ▷ You can operate your vehicle on uphill and downhill gradients with a maximum slope of 50%. If you intend to drive on either an uphill or downhill gradient of this steepness, check to be sure in advance that the engine oil and coolant levels are both near the MAX mark, refer to pages [141](#) and [143](#).

When driving down steep slopes, use the Hill Descent Control HDC, refer to page [93](#).

Starting from a full stop is possible on uphill gradients of up to 32%.

The permitted side tilt is also 50%

- ▷ While driving, watch carefully for obstacles such as rocks or holes. Try to avoid these obstacles whenever possible

- ▷ On hill crests and bumpy roads, for example, be careful to prevent the body from bottoming – contact between the body and the ground. The ground clearance of the vehicle is:

8 in/200 mm with up to four passengers

7 in/180 mm fully loaded – without self-leveling suspension

- ▷ Do not drive in water that is deeper than 20 inches/50 cm. If you must drive through water up to that depth, drive at a walking speed and do not stop.

After leaving the water, press on the footbrake gently several times while driving at a low speed. The brake applications will help to dry the brakes, thus preventing a reduction in braking performance caused by the moisture.

Back onto the paved road

In recommending that you observe the following points after driving on adverse road surfaces, it is not as a beauty treatment for your BMW. Instead, it is intended for the maintenance of driving safety:

- ▷ Clean accumulations of dirt from the body and check the undercarriage for damage
- ▷ Clean mud, snow, ice and other materials from the wheels and tires. Check the tires for damage
- ▷ Check to determine whether rocks, gravel or accumulations of dirt on the brake rotors and calipers could influence braking performance. Remove all such foreign objects
- ▷ In order to clean the brake rotors, apply the footbrake gently several times while driving at a low speed. Be sure that following traffic is not endangered by this
- ▷ For cleaning the parking brake, apply the lever slightly at approx. 25 mph/40 km/h and continue to drive for approx. 200 yards/200 meters, provided that traffic conditions allow you to do so.

**Brakes:**

Do not drive with your foot resting on the brake pedal. Even light but consistent pedal pressure can lead to high temperatures, brake wear and possibly even brake failure.

Hydroplaning:

When driving on wet or slushy roads, reduce vehicle speed. If you do not, a wedge of water may form between the tires and the road surface. This phenomenon is referred to as hydroplaning or aquaplaning. It is characterized by a partial or complete loss of contact between the tires and the road surface. The ultimate results are loss of steering and braking control. ◀

Antilock Brake System

The concept

The Antilock Brake System ABS keeps the wheels from locking during braking, thereby enhancing active driving safety.

Braking with ABS

If you are in a situation that requires full braking, you will exploit the full benefits of the ABS system if you apply maximum pedal pressure – panic stop.

Pulsation at the brake pedal combined with sounds from the hydraulic circuits indicates to the driver that ABS is in its active mode.

Brake system

Brake fluid level

If the brake fluid level is too low and brake pedal travel has become longer, there may be a defect in one of the two brake system's hydraulic circuits.



Proceed to the nearest BMW Sports Activity Vehicle center. Here increased pressure on the brake pedal may be required, and slight pulling to the side and longer braking distances may result. Please remember to adapt your driving style accordingly. ◀

Brake system

Disc brakes

When the vehicle is driven only occasionally, during extended periods when the vehicle is not used at all, and in operating conditions where brake applications are less frequent, there is an increased tendency for corrosion of the rotors and accumulation of contamination on the brake pads. This occurs because the minimal pressure which must be exerted by the pads to clean the discs by brake applications is not reached.

If the brake rotors are corroded, they will tend to respond to braking with a pulsating effect which even extended application will fail to cure.

When driving in wet conditions and in heavy rain, it is advisable to apply light pressure to the brake pedal from time to time. Watch traffic conditions to ensure that this maneuver does not endanger other road users. The heat which is generated by the brake applications helps to dry the brake pads and rotors. The braking force is then immediately available when required.

Extended or steep mountain descents should be driven in the gear in which only minimal periodic brake application is required. This avoids excessive strain on the brakes and possible impairment of the braking effect.



Do not coast with the clutch depressed or with the transmission or selector lever in neutral. Do not drive with the engine switched off. The engine provides no braking effect when the clutch is depressed or the transmission is in neutral, and there is no power-assist for braking or steering when the engine is not running. BMW recommends having brake inspections performed at a BMW Sports Activity Vehicle center only. If you do not, parts of the four-wheel drive system could be damaged. Never allow floor mats, carpets or any other objects to protrude into the area around the accelerator, clutch and brake pedals and obstruct their movement. ◀

Brake pads



For your own safety: use only brake pads that BMW has released for your particular vehicle model. BMW cannot evaluate non-approved brake pads to determine if they are suited for use, and therefore cannot ensure the operating safety of the vehicle if they are installed. ◀

Information for your safety

The factory-approved radial tires are matched to the vehicle and have been selected to provide optimum safety and driving comfort on your vehicle when used correctly.

It is not merely the tire's service life, but also driving comfort and – above all else – driving safety which depend on the condition of the tires and the maintenance of the specified tire pressure.

 Incorrect inflation pressure is a frequent cause of tire damage. It also significantly influences the road-holding ability of your BMW. Check tire inflation pressures – including the spare wheel – regularly, refer to page 26, at least every two weeks and before beginning a longer trip. If this is not done, incorrect tire pressures can cause driving instability and tire damage, ultimately resulting in an accident. ◀

Tire condition**Tire tread – Tire damage**

Inspect your tires frequently for tread wear, signs of damage and for foreign objects lodged in the tread. Check the tread pattern depth.

Tread depth should not be allowed to go below 0.12 in/3 mm, even though, the legally specified minimum tread depth, for example in Europe, is only 0.063 in/1.6 mm. Below a tread depth of 0.12 in/3 mm there is an increased risk of hydroplaning, even at relatively moderate speeds and with only small amounts of water on the road.

Tread wear indicators, refer to arrow, are embedded around the tire circumference in the base of the tire tread. Their locations are indicated on the tire sidewall with TWI – Tread Wear Indi-

cator. At a tread depth of 0.063 in/ 1.6 mm these indicators, signal that the tires have reached the legally permissible wear limit.

 Do not drive on a deflated – flat – tire. A flat tire greatly impairs steering and braking response, and can lead to complete loss of control over the vehicle.

Avoid overloading the vehicle so that the permitted load on the tires is not exceeded. Overloading leads to overheating and causes damage inside the tires. The ultimate result can assume the form of a sudden air loss. Unusual vibrations encountered during normal vehicle operation, e.g. caused by contact with curbs, etc., can indicate a flat tire or some other vehicle malfunction. This is also true for irregularities in the vehicle's handling characteristics, such as a pronounced tendency to pull to the left or right. Should this occur, respond by immediately reducing your speed.

Tire condition

Proceed carefully to the nearest BMW Sports Activity Vehicle center or professional tire center, or have the vehicle towed in to have it, its wheels and tires inspected.

Tire damage up to and including blow-outs can endanger the lives of both the vehicle occupants and other road users. ◀

Tire replacement

DOT Quality Grades

Tread wear
Traction AA A B C
Temperature A B C



All passenger car tires must conform to Federal Safety Requirements in addition to these grades. ◀

Tread wear

The tread wear grade is a comparative rating based on the wear rate of the tire when tested under controlled conditions on a specified government test course.

For example, a tire graded 150 would wear one and one-half – 1 ½ – times as well on the government course as a tire graded 100. The relative performance of tires depends upon the actual conditions of their use, however, and may depart significantly from the norm due to variations in driving habits, service practices and differences in road characteristics and climate.

Traction

The traction grades, from highest to lowest, are AA, A, B, and C. Those grades represent the tire's ability to stop on wet pavement as measured under controlled conditions on specified government test surfaces of asphalt and concrete. A tire marked C may have poor traction performance.



This tire is based on straight-ahead braking traction tests, and does not include acceleration, cornering, hydroplaning, or peak traction characteristics. ◀

Temperature

The temperature grades are A, the highest, B, and C, representing the tire's resistance to the generation of heat and its ability to dissipate heat when tested under controlled conditions on a specified indoor laboratory test wheel.

Sustained high temperature can cause the material of the tire to degenerate and reduce tire life, and excessive temperature can lead to a sudden flat tire. The grade C corresponds to a level of performance which all passenger car tires must meet under the Federal Motor Car Safety Standard No. 109. Grades B and A represent higher levels of performance on the laboratory test wheel than the minimum required by law.



The temperature grade for this tire is established for a tire that is properly inflated and not overloaded. Excessive speed, underinflation, or excessive loading, either separately or in combination, can cause heat buildup and possible a tire failure. ◀

Uniform Tire Quality Grading

Quality grades can be found where applicable on the tire sidewall between tread shoulder and maximum section width. For example:

Tread wear 200
Traction AA
Temperature A

Tire age

BMW recommends the replacement of all tires – i.e. also of the spare tire, independently of actual wear – when the tires are no more than 6 years old, even if a tire life of 10 years is possible.

The date on which the tire was manufactured is indicated by the code on the sidewall:

DOT ... 2602 indicates that the tire was manufactured in week 26 of 2002.

Wheel and tire combinations

The right choice

 Use only wheels and tires approved by BMW for the corresponding vehicle model, as otherwise the tires may make contact with the body as the result of tolerances despite the same nominal size being used, resulting in serious accidents. If non-approved wheels and tires are used, BMW cannot evaluate their suitability, and therefore cannot be held liable for driving safety. ◀

BMW tests certain tire brands for each tire size, classifies them as road-safe and approves them. Consult your BMW Sports Activity Vehicle center for more information. Observe any regulations applicable in the country of use, e.g. requiring entry in the vehicle documents.



The correct wheel and tire combination affects different systems such as ABS, ATC and DSC. The function of these systems is impaired if improper wheel and tire combinations are used.

For this reason, use only tires of the same brand and tread pattern on the vehicle and, for example, restore the approved wheel and tire combination following a flat tire as soon as possible. ◀



The use of rims and lug bolts that do not meet the specifications of the original factory-installed equipment will affect the safe operation of your vehicle and may cause an accident and personal injury.

Never mix tires of different design, such as steel-belted radials with radial bias belted or bias-ply tires, etc. Mixing tire types will adversely affect roadholding and can lead to loss of vehicle control. ◀

Storage

Store wheels or tires in a cool, dry place, protecting them against light whenever possible. Protect the tires against contact with oil, grease and fuel.

Choosing the right tire

BMW recommends winter tires – M+S radial tires – for operation under inclement winter driving conditions. While so-called all-season tires with M+S designation provide better winter traction than summer tires with the load ratings H, V, W, Y and ZR, they generally do not achieve the performance of winter tires.

In the interests of safe tracking and steering response, install radial tires made by the same manufacturer and with the same tread configuration on all four wheels if you elect to mount winter tires.

Do not exceed specified maximum speeds

Never exceed the maximum speed for which the tires are rated. Unprofessional attempts by laymen to service tires can lead to damage and accidents.

Have this work performed by skilled professionals only. Your BMW Sports Activity Vehicle center will be glad to assist you with both their expertise and the proper equipment for your vehicle. ◀

Tire condition, tire pressure

Winter tires display a perceptible loss in their ability to cope with winter driving conditions once the tread wears to below 0.16 in/4 mm, and should thus be replaced.

Comply with the specified tire inflation pressures – and be sure to have the wheel and tire assemblies balanced every time you change the tires.

Snow chains*

Only certain snow chains have been tested by BMW and classified and approved as safe. Consult your BMW Sports Activity Vehicle center for details. The use of narrow-link BMW snow chains is approved only in pairs on the rear wheels and only with the following tire sizes.

BMW X5 4.6is: 255/55 R18

All other models: 235/65 R 17.

Comply with all manufacturer's safety precautions when mounting the chains. Do not exceed a maximum speed of 30 mph/50 km/h.

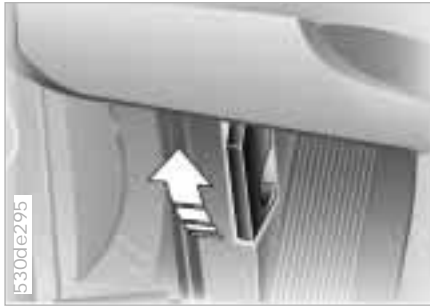

To unlock

Pull the lever located under the left-hand side of the instrument panel.

 Do not work on your vehicle without appropriate skills. Failure to work in an informed, professional manner when servicing components and materials constitutes a safety hazard for vehicle occupants and other road users. If you are not familiar with the guidelines, please have the operations performed by your BMW Sports Activity Vehicle center. ◀



To open

Pull the release handle and open the hood.

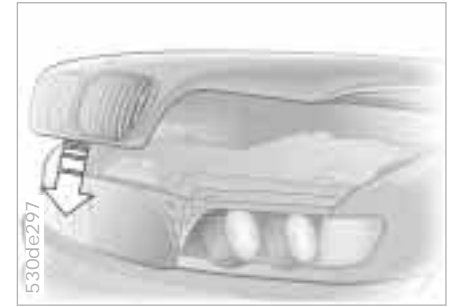

To close

Allow the hood to fall from a height of about 12 in/30 cm so that it audibly engages.

 To avoid injuries, be sure that the travel path of the hood is clear when it is closed, as with all closing procedures. If it is determined that the hood is not completely closed while driving, stop immediately and close it securely. ◀

140 Engine compartment essentials



1 Engine oil dipstick [141](#)

2 Reservoir for brake fluid – under the microfilter trim panel [144](#)

3 Auxiliary terminal for jump starting [162](#)

4 Coolant expansion tank [143](#)

5 Engine oil filler neck [141](#)

6 Reservoir for windshield and headlamp washer system [141](#)

Washer fluid



Windshield and headlamp washer system

Approximate capacity is 8.2 US quarts/ 7.8 liters.

Fill with water and – if required – with a washer antifreeze, according to manufacturer's recommendations.

 It is more convenient to mix the washer fluid before adding it to the reservoir. ◀

 Antifreeze agent for the washer systems is inflammable. For this reason, keep it away from sources of flame and store it only in its original containers. Store it so that it is inaccessible to children. Comply with the instructions on the containers. ◀

Engine oil



Checking oil level

1. Park the vehicle on a level surface
2. Switch the engine off after it has reached normal operating temperature
3. After approx. 5 minutes, pull the dipstick out and wipe it off with a clean lint-free cloth, paper towel, or similar material
4. Push the dipstick carefully all the way into the guide tube and pull it out again
5. The oil level should be in between the two marks on the dipstick.

As with fuel economy, oil consumption is directly influenced by your driving style and vehicle operating conditions.



The oil volume between the two marks on the dipstick corresponds to approx. 1.1 US quarts/1 liter. Do not fill beyond the upper mark on the dipstick. Excess oil will damage the engine

BMW X5 4.6is:

If the vehicle's performance reserves are used extensively – high-performance driving – the oil level should be maintained at the upper mark on the dipstick.

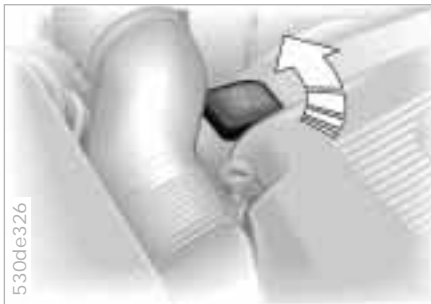

To add oil

While you should wait until the level has dropped to just above the lower mark before adding oil, you should never allow the oil level to fall below this marking.

 BMW engines are designed to operate without oil additives; the use of additives could lead to damage in some cases. This is also true for the manual transmission, the automatic transmission, the differential, and the power steering system. ◀

Recommendation: have the oil changed by your BMW Sports Activity Vehicle center.

 Continuous exposure to used oil has caused cancer in laboratory testing. For this reason, any skin areas that come into contact with oil should be thoroughly washed with soap and water.

Always store oils, grease and similar materials so that they are inaccessible to children. Comply with warning labels and information on containers. ◀

 Comply with the applicable environmental laws regulating the disposal of used oil. ◀

Specified engine oils

The quality of the engine oil selected has critical significance for the operation and service life of an engine. Based on extensive testing, BMW has approved only certain engine oils.

Use only approved BMW High Performance Synthetic Oil.

If you are unable to obtain BMW High Performance Synthetic Oil, you can add small amounts of synthetic oil in between oil changes. Use only oils with the API SH specification or higher.

 Ask your BMW Sports Activity Vehicle center for details concerning the specific BMW High Performance Synthetic Oil or synthetic oils which have been approved. ◀

You can also call BMW of North America at 1-800-831-1117 or visit this website: www.bmwusa.com to obtain this information.

Viscosity ratings

Viscosity is the oil flow rating as established in SAE classes.

The selection of the correct SAE class depends on the climatic conditions in the area where you typically drive your BMW.

 Approved oils are in SAE classes 5W-40 and 5W-30. ◀

These oils may be used for driving in all ambient temperatures.

Coolant

 Do not add coolant to the cooling system when the engine is hot. If you attempt to do so, escaping coolant can cause burns.

To avoid the possibility of damage later on, never use anything other than factory-approved, nitrite and amino-free extended-duty antifreeze with corrosion inhibitor. Your BMW Sports Activity Vehicle center is familiar with the factory specifications.

Antifreeze and anticorrosion agents are hazardous to health. You should always store them in their original container and in a location which is inaccessible to children.

Extended-duty antifreeze with corrosion inhibitor contains the flammable substance ethylene-glycol. For this reason, do not spill antifreeze with corrosion inhibitor on hot engine parts. It could ignite and cause serious burns. ◀



Checking coolant level and adding coolant

Correct coolant level when the engine is cold approx. +68 °F / +20 °C:

1. Start by turning the cap of the expansion tank counterclockwise. Pause to allow any accumulated pressure to escape, then open
2. The coolant level is correct when the end of the red float is aligned with the upper edge of the filler opening, refer to the arrow in the illustration, or max. 0.8 in/2 cm higher, i. e. up to the mark on the float, refer also to the schematic diagram, next to the cap

3. If necessary, add coolant. Slowly add coolant until the correct level is reached – do not overfill.

 Comply with the applicable environmental laws regulating the disposal of extended-duty antifreeze with corrosion inhibitor. ◀

Brake fluid level

If the indicator lamp for the brake hydraulic system appears or if the CHECK BRAKE FLUID warning appears in the Check Control: the brake fluid level is too low.

**Add brake fluid**

The brake fluid reservoir is located under the microfilter housing trim panel on the driver's side of the vehicle. For adding brake fluid or for determining and correcting the cause of brake fluid loss, consult your BMW Sports Activity Vehicle center. Your BMW Sports Activity Vehicle center is familiar with the specifications for factory-approved brake fluids – DOT 4.

Brake fluid loss may result in extended brake pedal travel. For this situation, refer to the notes on page [132](#).



Brake fluid is hygroscopic, that is, it absorbs moisture from the air over time.

In order to ensure the safety and reliability of the brake system, have the brake fluid changed every two years by a BMW Sports Activity Vehicle center. Refer also to the Service and Warranty Information Booklet for US models or the Warranty and Service Guide Booklet for Canadian models.

Brake fluid is toxic and damages the vehicle's paint. You should always store it in its original container and in a location which is out of reach of children. Do not spill the fluid and do not fill the brake fluid reservoir beyond the MAX mark. The brake fluid could ignite upon contact with hot engine parts and cause serious burns. ◀



Comply with the applicable environmental laws regulating the disposal of brake fluid. ◀



The BMW Maintenance System has been designed as a reliable means of providing maximum driving and operating safety – and as cost-effectively as possible for you.

Please keep in mind that regular maintenance is not only necessary for the safety of your vehicle, but also plays a significant role in maintaining the resale value of the vehicle.

Service Interval Display

Conventional systems rely solely on distance traveled to determine when service is due. The BMW Maintenance System, on the other hand, began many years ago to take the actual conditions under which the vehicle is driven into consideration. After all, different drivers can accumulate mileage in very different ways.

From the point of view of maintenance, 62,000 miles/100,000 km accumulated in short-distance urban driving are not the equivalent of the same distance covered at moderate speeds in long-distance highway travel.

The BMW Maintenance System includes the Engine Oil Service and Inspections I and II.

Determining the maintenance intervals according to the actual loads on the vehicle covers every kind of operating situation. However, even those who drive only short distances – significantly less than 6,000 miles/10,000 km annually – should have the engine oil changed at least every 2 years since oil deteriorates over time, regardless of use.

Service and Warranty Information Booklet – US models/Warranty and Service Guide Booklet – Canadian models

For additional information on maintenance intervals and procedures, please refer to the Service and Warranty Information Booklet for US models or the Warranty and Service Guide Booklet for Canadian models.

As a precaution against corrosion, it is advisable to have the body checked for damage from rocks or gravel at the same time, depending upon operating conditions.

 Have your BMW Sports Activity Vehicle center do the maintenance and repair.

Be sure that all maintenance work is confirmed in the Service and Warranty Information Booklet for US models or the Warranty and Service Guide Booklet for Canadian models. These entries will constitute your proof that the vehicle has received regular maintenance. They are also required for warranty claims. ◀

Car care

For all information on this subject, refer to the Caring for your vehicle manual.

Light-emitting diodes – LEDs

Light-emitting diodes installed behind translucent lenses serve as the light source for many of the controls and displays in your vehicle. The concept behind their operation is related to that employed for lasers.



Do not remove the protective lens and avoid staring directly at the unfiltered beam for several hours, as inflammation of the iris could result. ◀

California laws require us to state the following warning:



Engine exhaust, some of its constituents, and certain vehicle components contain or emit chemicals known to the State of California to cause cancer and birth defects and reproductive harm. In addition, certain fluids contained in vehicles and certain products of component wear contain or emit chemicals known to the State of California to cause cancer and birth defects or other reproductive harm. Battery posts, terminals and related accessories contain lead and lead compounds. Wash your hands after handling. Used engine oil contains chemicals that have caused cancer in laboratory animals. Always protect your skin by washing thoroughly with soap and water. ◀

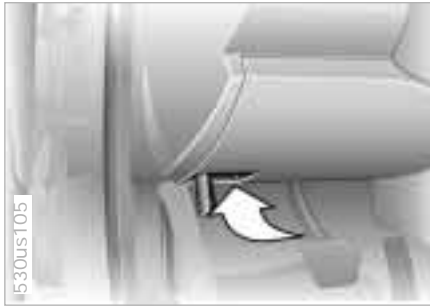

The interface socket for the Onboard Diagnostic is located on the left of the driver's side at the bottom of the instrument panel and under a cover. The cover has the letters OBD on it.

The purpose of the OBD system is to ensure proper operation of the emission control system for the vehicle's lifetime. The system monitors emission-related components and systems for deterioration and malfunction.



An illuminated lamp informs you of the need for service, not of the need to stop the vehicle.

However, the systems should be checked by your BMW Sports Activity Vehicle center at the earliest possible opportunity.

Under certain conditions, the indicator will blink or flash. This indicates a rather severe level of engine misfire. When this occurs, you should reduce speed and consult the nearest BMW Sports Activity Vehicle center as soon as possible. Severe engine misfire over only a short period of time can seriously damage emission control components, especially the catalytic converter.



Service Engine Soon warning lamp for Canadian models.



When the filler cap is not properly tightened, the OBD system can detect the vapor leak and the indicator will light up. If the filler cap is subsequently tightened, the indicator should go out within a few days. ◀



Overview

Controls and features

Operation, maintenance

Owner service procedures

Technical data

Index

Overview

Controls

Maintenance

Repairs

Data

Index





Under the cargo area floor in a pocket.

Windshield wiper blades



Front

1. Move the wiper to a fold-out position, refer to page 68
2. Lift the wiper arm and press the securing spring, refer to arrow
3. Pull the wiper blade off toward the wiper arm
4. Insert the new blade and snap it into place.

 Fold the wipers back down onto the windshield before you turn the ignition key to position 1 or 2 again. If you do not, they could be damaged. ◀



Rear

1. Hold the wiper blade on the window and remove/unclip the wiper arm at the articulated joint, refer to arrow
2. Insert a new wiper blade and press it on/clip it into the wiper arm.

 Use only wiper blades approved by BMW. ◀

Lamps and bulbs

The lamps and bulbs make essential contributions to the safety of your vehicle. For this reason, follow the instructions below carefully when replacing a bulb. If you are not familiar with any of the procedures, consult your BMW Sports Activity Vehicle center.

 Do not touch the glass portion of a new bulb with your bare hands since even small amounts of impurities burn into the surface and reduce the service life of the bulb. Use a clean cloth, paper napkin, or a similar material, or hold the bulb by its metallic base. ◀

A replacement bulb set is available from your BMW Sports Activity Vehicle center.

 Whenever working on the electrical system, switch off the electrical accessory you are working on or disconnect the cable from the negative terminal of the battery. Failure to do this could result in short circuits. Comply with any instructions provided by the bulb manufacturer. If you do not, injuries and damages during the bulb replacement can occur. ◀

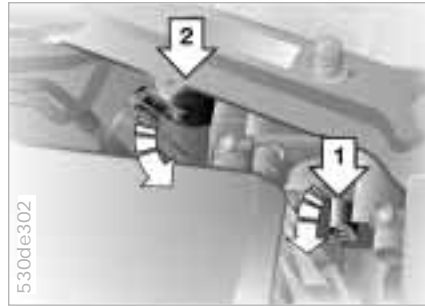

The right side of the engine compartment.

- 1 Low beams
- 2 High beams

 For checking and adjusting headlamp aim, please contact your BMW Sports Activity Vehicle center. ◀

Low beams

H7 bulb, 55 watts

 The bulb is pressurized. Therefore, wear safety glasses and protective gloves. Failure to comply with this precaution could lead to injury if the bulb is accidentally damaged during replacement. ◀

1. Turn the bulb holder to the left, refer to arrow, and remove
2. Remove and replace the bulb.

High beams

HB3 bulb, 60 watts

 The bulb is pressurized. Therefore, wear safety glasses and protective gloves. Failure to comply with this precaution could lead to injury if the bulb is accidentally damaged during replacement. ◀

1. Turn the bulb holder to the left and remove
2. Disconnect the plug
3. Plug the new bulb into the plug connector. Be sure that it is securely engaged
4. Install in the opposite order.

Xenon lamps*

The operating life of these lamp units is extremely long and the likelihood of failure very low, provided that they are not switched on and off a very great number of times. If one of these bulbs should nevertheless fail, it is possible to continue driving with great caution using the fog lamps, provided traffic laws in your area do not prohibit this.

 Because of the extremely high voltages involved, any work on the xenon lighting system should be carried out by technically-qualified personnel only. Failure to comply with this creates a risk of fatal injury. ◀

Turn signal indicators/Standing lamps – side marker lamps – front

Dual-filament bulb, 28/8 watts

Please contact a BMW Sports Activity Vehicle center in case of a malfunction.

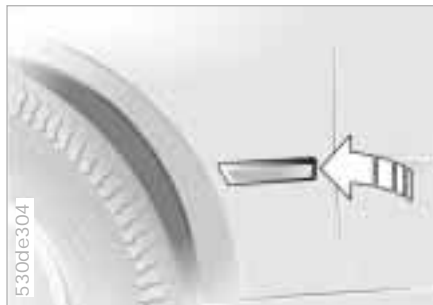

Side turn signal indicators

5 watt bulb

1. Use finger pressure against the rear end of the lamp, refer to arrow, to press it forward for removal
2. Press gently on the bulb and turn it to the left to remove it
3. Replace the bulb.

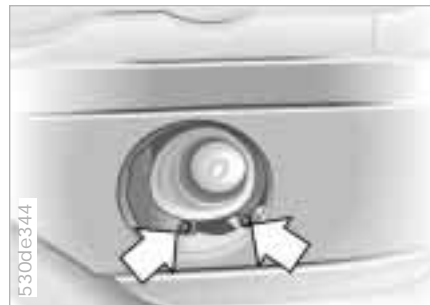

Front fog lamps

H3 bulb, 55 watts

 The bulb is pressurized. Therefore, wear safety glasses and protective gloves. Failure to comply with this precaution could lead to injury if the bulb is accidentally damaged during replacement. ◀

1. Pull the cover in front of the fog lamp forward
2. Loosen the two screws, refer to arrows, and remove the fog lamp
3. Turn the cover cap on the rear of the fog lamp to the left and remove
4. Unhook the wire clamp, remove the contact base and replace the bulb.

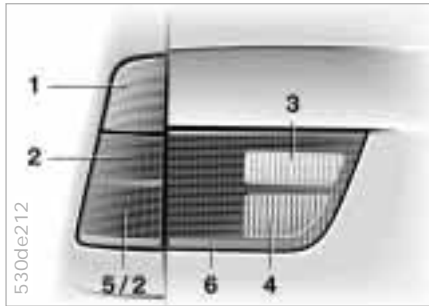

Tail lamp assembly

Tail lamp 2: 21/5 watt bulb
Remaining bulbs: 21 watts

- 1 Turn signal indicator
- 2 Rear lamps/Side marker lamps
- 3 Backup lamps
- 4 Brake lamps
- 5 Reflector



Lamps in the side panel:

1. Open the cover in the side panel
2. Lift the side panel if necessary
3. Press gently on the bulb holder and turn it to the left to remove it
4. Remove the bulb.

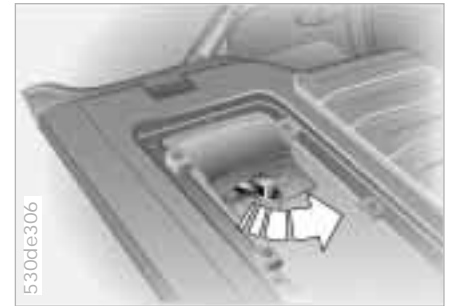

Lamps in the tailgate:

1. Unclip the trim panel in the tailgate with a screwdriver
2. Press gently on the bulb holder and turn it to the left to remove it
3. Remove the bulb.

Center - high-mount - brake lamp

LED strip in the rear spoiler: please contact a BMW Sports Activity Vehicle center in case of a malfunction.

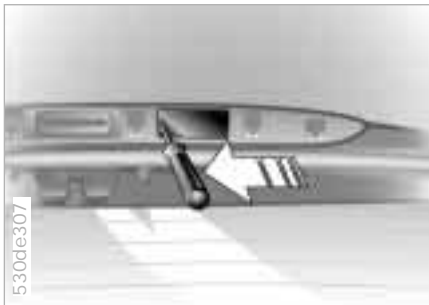

License plate lamps

5 watt bulb

1. Press the lamp out to the side with a screwdriver
2. Remove the lamp and replace the bulb.

Changing a wheel



Safety precautions in the event of a flat tire or wheel change:

Stop the vehicle as far as possible from passing traffic. Park on a firm flat, surface. Switch on the hazard warning flashers.

Turn the steering wheel to the straight-ahead position, remove the key and engage the steering lock. Shift into 1st or reverse, selector lever in Park with automatic transmission, and engage the parking brake.

All passengers should be outside the vehicle and well away from your immediate working area, behind a guardrail, for instance.

If a warning triangle or portable hazard warning lamp is required, set it up on the roadside at an appropriate distance from the rear of the vehicle.

Comply with all safety guidelines and regulations.

Change the wheel only on a level, firm surface which is not slippery. Avoid jacking the vehicle up on a soft or slippery surface, snow, ice, very smooth surfaces, etc., since it could slide sideways.

Position the jack on a firm support surface.

Do not place wooden blocks or similar objects under the jack. If this is done, the jack might not be able to reach its full support capacity because of the limited height.

Do not lie under the vehicle or start the engine when the vehicle is supported by the jack. Failure to comply with this creates a risk of fatal injury. ◀

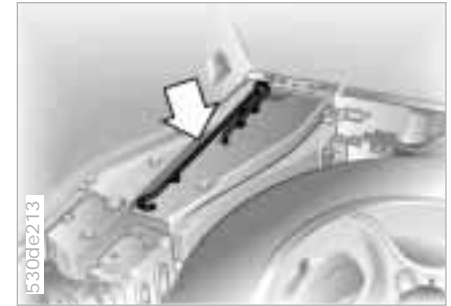

What you will need

In order to avoid rattling noises later, note the position of the tools when you remove them and return them to their original position when you are through using them.

- ▷ Two wedges – wheel chocks
Open the liftgate and tailgate.
In the cargo area, fold up the floor cover or pull-out cargo floor, refer to pages [123](#), [124](#) or [125](#).
Take out the wedges, refer to arrow, next to the spare wheel

- ▷ Lug wrench
Is located next to the spare wheel

- ▷ Handle for the jack
Remove from its holder



▷ **Jack**

Remove the rubber band from the holder, refer to arrow, and take out the jack.

When you have completed work, screw the jack all the way back down, remove the handle and insert it into its holder.

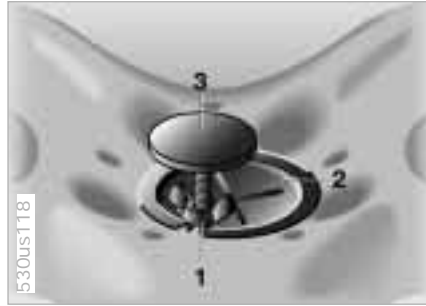

Spare wheel

1. Loosen the wing nut 1
2. Remove the plate 2 to the side
3. Unscrew the threaded rod 3 completely.



Removal aid for the spare wheel

By using this device, you do not have to lift the spare wheel out of the recess by hand.

Its task is to help you to move the wheel onto the tailgate, from where you can easily lift it off.

1. Close the tailgate again
2. Grasp the handle of the removal aid behind the spare wheel with both hands and pull upward over the tailgate, refer to arrow



3. Hook both buckles into the latch of the tailgate, refer to arrow; the tailgate is released



4. Remove the support rod from the bracket



5. Press the tailgate down and hold it there. The spare wheel is now pulled by means of the removal aid onto the tailgate

 Hold the tailgate in the opened position and do not allow it to retract sharply upward. If you do so, there is a risk of personal injury and vehicle damage. ◀

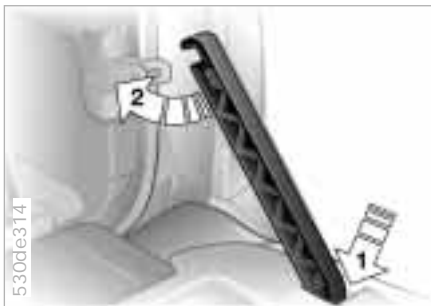

6. Insert the support rod in the tailgate lock and press down until it engages, refer to arrow 1; then lock hook of rod in striker, refer to arrow 2



Be sure that the support rod is locked firmly in place. If you fail to do so, it could retract sharply upward and cause personal injury and vehicle damage. ◀

7. You can now release the locked tailgate and take the spare wheel down from the tailgate. It is recommended that you leave the tailgate locked into place until you have completed the wheel change and placed the wheel with the defective tire into the removal aid.

Procedure

1. Read carefully and comply with the safety precautions on page 154
2. Secure the vehicle to prevent it from rolling:

Place the wedges (chocks) behind the wheels on the side opposite the side you are lifting. If the vehicle is parked on a downward slope, place the wedges securely in front of the wheels. If the wheel must be changed on a surface with a more severe slope, take additional precautions to secure the vehicle from rolling

3. Loosen the lug bolts 1/2-turn
4. Insert the jack handle into the jack, refer to the illustration in the next column

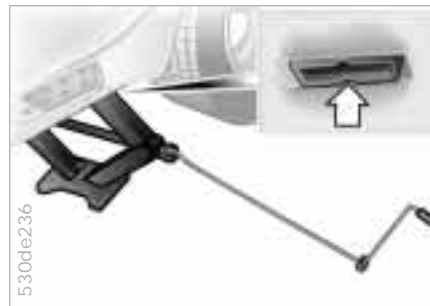

5. Position the jack at the jacking point closest to the flat tire so that the jack base is vertically below the jacking point and the entire surface of the head of the jack will move into the square recess of the jacking point, refer to the illustration detail, when the jack is cranked
6. Jack the vehicle up until the wheel you are changing is raised from the ground
7. Unscrew the lug bolts and remove the wheel
8. Remove accumulations of mud or dirt from the mounting surfaces of the wheel and hub. Clean the lug bolts

Changing a wheel

9. Position the spare wheel. Secure the wheel by turning at least two lug bolts into opposite bolt holes
10. Screw in the remaining lug bolts. Tighten all the bolts securely
11. Lower the jack and remove it from beneath the vehicle
12. Tighten the lug bolts in a diagonal pattern
13. Check and correct the tire inflation pressure at the earliest opportunity. Vehicles with Tire Pressure Monitor RDC*:
After mounting the spare wheel or correcting the tire inflation pressure, reactivate the system, refer to page 97.

Protect valve stems and valves from dirt using screw-on valve stem caps. Dirt in the valve stems frequently leads to slow leaks.



The vehicle jack is designed for changing wheels only. Do not attempt to raise another vehicle model with it or to raise any load of any kind. To do so could cause accidents and personal injury. To ensure continued safety, have the tightness of the lug bolts checked with a calibrated lug wrench – torque specification: 101 lb-ft/140 Nm – at the earliest opportunity. ◀

Store the wheel and the tools in the order opposite that for removal.



Before removing the support rod, be sure that the tailgate is held down firmly. If you fail to do so, it could retract sharply upward and cause personal injury and vehicle damage. After you remove the rod, close the tailgate carefully. Continue to hold it firmly until it is completely closed. ◀

If light-alloy wheels other than original BMW light-alloy wheels have been mounted, it may be necessary to use different lug bolts for those wheels.

Replace the defective tire as soon as possible and have the new wheel/tire balanced.

Driving with spare wheel



With certain wheel-and-tire combinations the size of the spare wheel differs from that of the other wheels. The spare wheel is equivalent to these in all speed and load ranges. However, to restore the original state, the normal wheel should be remounted as soon as possible.

When the spare wheel is mounted, the maximum speed rating is 130 mph/210 km/h. ◀

 Battery posts, terminals and related accessories contain lead and lead compounds. Wash hands after handling. ◀

Maintenance

The battery is maintenance-free, that is, the original electrolyte will normally last for the service life of the battery under moderate climatic conditions.

 For all questions that regard the battery, please consult your BMW Sports Activity Vehicle center. Since the battery is maintenance-free, the following is for your information only. ◀

 Do not disconnect the battery when the engine is running. If you do so, the ensuing voltage surge will damage the vehicle's onboard electronics. ◀

Charging the battery

Charge the battery in the vehicle only when the engine is not running. Use the connections provided in the engine compartment. For correct connections, refer to Jump-starting on page 162.

Disposal

 Return used batteries to a recycling point or your BMW Sports Activity Vehicle center. Maintain the battery in an upright position for transport and storage. Secure the battery against tilting during transport. ◀



In the glove compartment

Open the glove compartment and turn the two quick-release fasteners to the left.

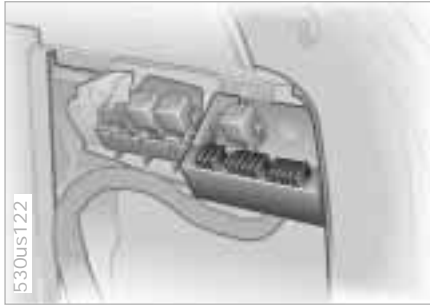

In the cargo area

Open the right cover by pulling the handle.



Do not attempt to repair a burned fuse or replace it with a fuse having a different color or ampere rating. To do this could cause a fire in the vehicle resulting from a circuit overload. ◀

162 Jump-starting

When your battery is discharged you can use two jumper cables to start your vehicle with power from the battery in a second vehicle. You can also use the same method to help start another vehicle. Always use jumper cables with fully insulated handles on the terminal clamps.

 Do not touch the live parts while the engine is running. Failure to comply with this creates a risk of fatal injury. Carefully observe the following instructions to avoid personal injury and/or damage to one or both vehicles. ◀

1. Make sure, that the battery on the support vehicle is rated at 12 volts. This information is provided on the battery label
2. Switch off the engine of the support vehicle. Switch off all electrical accessories in both vehicles – except the hazard warning flashers of the support vehicle
3. Make absolutely certain that there is no contact between the bodywork of the two vehicles – risk of short circuit



4. The so-called jump start auxiliary terminal in the engine compartment of your BMW acts as the positive battery terminal. The cap of this jump start auxiliary terminal is identified by a + symbol. To open, tip up the cap, refer to arrow.
First connect a jump start cable to the positive terminal of the discharged battery, and the other end to the positive terminal of the support vehicle

Jump-starting

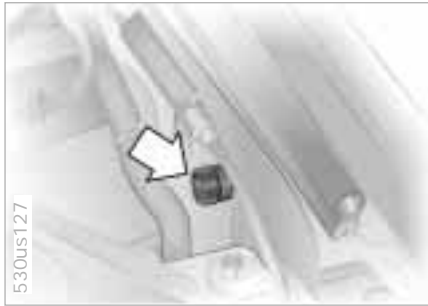

5. With the second jumper cable, connect the negative terminals of the two vehicles. First connect the cable to the support vehicle's negative battery terminal or a suitable ground on its engine or bodywork, and then the other end to the negative battery terminal or a suitable ground on the engine or bodywork of the vehicle being started. There is a special nut for this purpose on the left side panel of your BMW, refer to the arrow in the illustration

 Always adhere to this sequence when connecting jumper cables; failure to observe this procedure can lead to sparks at the battery terminals and pose an injury hazard. ◀

6. Start the support vehicle's engine and let it run at an increased idling speed for a few minutes
7. Start the engine on the vehicle needing the jump-start, and allow it to run as usual. If the first start attempt is not successful, wait a few minutes before another attempt in order to allow the discharged battery to recharge
8. Before disconnecting the jumper cables let the engines run for a few minutes
9. Then disconnect the jumper cables in reverse sequence.

Depending on the cause of the fault, have the battery recharged by your BMW Sports Activity Vehicle center.

 Do not use spray starter fluids to start the engine. ◀



Tow fitting

The screw-in tow fitting is stored beneath the cargo area floor. Carry it with you at all times. This fitting is designed for installation in the tow sockets located at the front and rear of the vehicle, and is intended for towing on paved road surfaces only. It should not be used to pull a vehicle out of deep snow, mud, sand, etc. Always observe all applicable towing laws and regulations.

Access to tow sockets

Front:

Use a screwdriver to press the right or left cover out, refer to arrows.





Rear:

Pull the cover off.

 Screw the tow fitting in until it is tight. If you do not, the threads could be damaged. Do not tow the vehicle by any components of the running gear, or lash them down in any way. If you do so, the components could be damaged, leading to possible accidents. ◀

Use only a nylon towing strap to tow the vehicle, since the inherent resilience of this material helps protect both vehicles from sudden jerking movements.

 Avoid off-center towing. Be sure that the tow rope is pulled tightly when the towing vehicle begins to move. ◀

 Do not tow a vehicle heavier than your own. If you do, it is no longer possible to control vehicle response. ◀

Tow-starting

It is not possible to start the engine of a vehicle equipped with an automatic transmission by towing or pushing.

For instructions on Jump starting refer to page [162](#).

Never attempt to use your vehicle to push another vehicle. If you do so, damage to the energy-absorbing bumpers could result.

Towing the vehicle

Towing a vehicle with automatic transmission

1. Place the selector lever in position N
2. Towing speed:
Maximum 45 mph/70 km/h
3. Towing distance:
Maximum 95 miles/150 km
4. Turn the ignition key to position 1 to ensure that the brake lamps, turn signal indicators, horn and windshield wipers remain operative, and to prevent the steering lock from engaging
5. Switch on the hazard warning flashers, comply with country-specific regulations.

In the event of electrical malfunction, find some means of identifying the vehicle in tow, for instance, place a sign or warning triangle in the rear window.

 Make sure that the ignition key remains in position 1 even when the electrical system has failed. This will prevent the steering lock from engaging. The steering and brakes are without power assist when the engine is not running. This means that increased effort is required for steering and braking. ◀

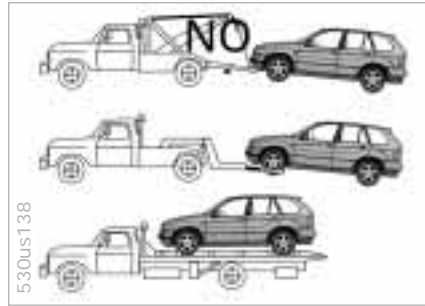

Towing with a commercial tow truck

- ▷ Do not tow with sling-type equipment
- ▷ Use a wheel-lift or flatbed carrier
- ▷ Please comply with applicable towing laws.

 Never allow passengers to ride in a towed vehicle for any reason. ◀

Towing with a raised axle

1. Place the gearshift lever or selector lever in Neutral
2. Turn the ignition key to position 0 or remove it
3. Towing speed:
Maximum 30 mph/50 km/h
4. Towing distance:
Maximum 95 miles/150 km.

 Remove the rear driveshaft for longer towing distances with the front axle lifted; remove the front driveshaft for towing over longer distances with the rear axle lifted. Failure to comply with this will result in damage to the transfer box. ◀

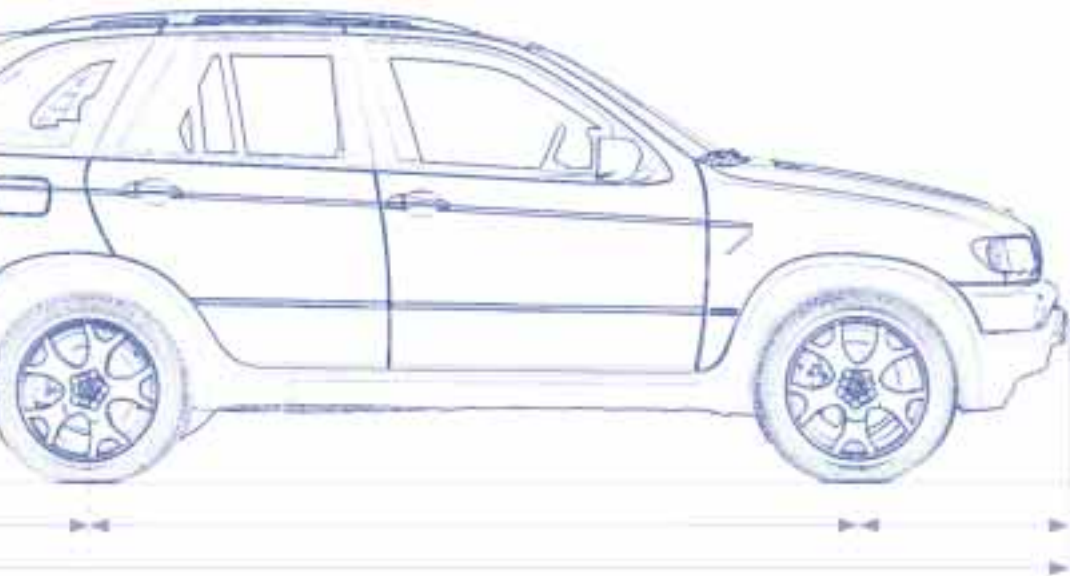

Overview

Controls and features

Operation, maintenance

Owner service procedures

Technical data

Index



Overview

Controls

Maintenance

Repairs

Data

Index

168 Engine specifications

		BMW X5 3.0i	BMW X5 4.4i	BMW X5 4.6is
Displacement	cu in/cm ³	181.8/2,979	268.4/4,398	281.9/4,619
Number of cylinders		6	8	8
Maximum output at engine speed	hp rpm	225 5,900	290 5,400	340 5,700
Maximum torque at engine speed	lb-ft/Nm rpm	214/290 3,500	324/440 3,600	350/475 3,700
Compression ratio		10.2	10.0	10.5
Stroke	in/mm	3.53/89.6	3.26/82.7	3.35/85.0
Bore	in/mm	3.31/84	3.62/92.0	3.66/93.0
Fuel-injection system		Digital electronic engine-management system		

An engine performance test is authorized only on an appropriate chassis dynamometer.

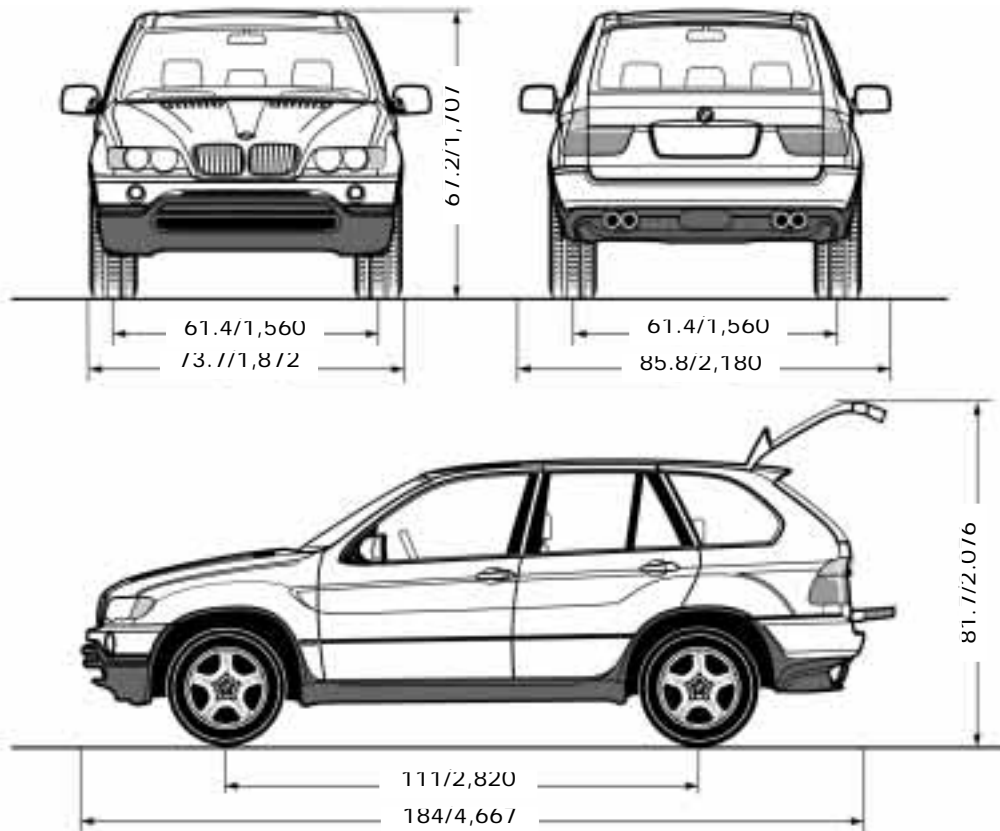

All dimensions are given in inch/mm. Height: with level control system: 67.2/1,707; without level control system: 67.5/ 1,715. Height with roof-mounted luggage rack: with level control system: 68.5/1,740; without level control system: 68.8/1,748. Track width X5 3.0i: 62.0/1,576; X5 4.6is: front 61.7/1,566, rear 62.8/1,596. Min. turning circle dia.: 39.7 ft/12.1 meters

530de339

170 **Weights**

		BMW X5 3.0i	BMW X5 4.4i	BMW X5 4.6is
Curb weight – with one person, ready for operation, full tank of fuel, options not included				
with manual transmission	lbs/kg	4,533/2,056	–	–
with automatic transmission	lbs/kg	4,586/2,080	4,824/2,188	4,824/2,188
Approved gross vehicle weight				
with manual transmission	lbs/kg	6,005/2,724	–	–
with automatic transmission	lbs/kg	6,005/2,724	6,005/2,724	6,005/2,724
Approved front axle load	lbs/kg	2,787/1,264	2,787/1,264	2,787/1,264
Approved rear axle load	lbs/kg	3,307/1,500	3,307/1,500	3,307/1,500
Approved roof load capacity	lbs/kg	220/100		
Never exceed either the approved axle loads or the gross vehicle weight.				
Cargo area capacity	cu ft/l	16.4 – 54.4/465 – 1,540 – according to DIN 69.04/1,955 – according to SAE		

			Notes
Fuel tank	gal./liters	approx. 24.6/approx. 93	Fuel specification: page 26
Reserve	gal./liters	approx. 2.0/approx. 8 – BMW X5 3.0i approx. 2.5/approx. 10 – BMW X5 4.4i, 4.6is	
Windshield washer system with headlamp washer system	quarts/liters	approx. 8.2/approx. 7.8	For details: page 141
Cooling system including heater circuit	quarts/liters	11.1/10.5 – BMW X5 3.0i 13.7/13.0 – BMW X5 4.4i, 4.6is	For details: page 143
Engine oil and filter change	quarts/liters	8.0/7.5 – BMW X5 3.0i 8.5/8.0 – BMW X5 4.4i, 4.6is	BMW High Performance Synthetic Oil For details: page 142
Manual and automatic transmission, transfer box and differential	–	–	Lifetime fluid, no fluid change required

A B C

P Q R

Overview

Controls and features

Operation, maintenance

Owner service procedures

Technical data

Index

Overview

Controls

Maintenance

Repairs

Data

Index



Everything from A to Z

A

ABS Antilock Brake System 20, 132
Accessories 9
Activated-charcoal filter 110
Adaptive brake light 98
Adding
 brake fluid 144
 coolant 143
 engine oil 141
 washer fluid 141
Adjusting
 head restraints 47
 mirrors 53
 seats 44
 steering wheel 52
 thigh support 45
Air conditioner 102
Air distribution 103, 107
Air outlets 102, 105
Air supply 103, 107
Airbags 20, 55
Alarm system 39
Antifreeze 143
Antilock Brake System
 ABS 20, 132
Anti-theft system 31
Approved gross vehicle weight 170
Aquaplaning 132, 134

Arrival time 87
Ashtray
 front 117
 rear 118
AUC Automatic recirculated-air control 108
Automatic climate control 105
 removing condensation from the windows 107
Automatic cruise control 71
Automatic curb monitor 51
Automatic dimming
 exterior rearview mirrors 54
 interior rearview mirror 54
Automatic headlamp control 99
Automatic recirculated-air control AUC 108
Automatic steering wheel adjustment 52
Automatic transmission with Steptronic 65
Average fuel consumption 80
Average speed 80, 88
Avoiding unintentional alarms 40
Axle loads 170

B

Backup lamps 65
 bulb replacement 153
Battery 160
 charge 160
 discharged 163
Battery charge indicator lamp 19
Battery, disposal 160
Belts 49
Beverage holder 116
Blower 103, 107
BMW comfort seat 46
BMW High Performance Synthetic Oil 142
BMW Maintenance System 145
BMW sports seat 45
BMW Universal Transmitter 112
Brake fluid 144
Brake fluid level 144
Brake lamps
 bulb replacement 153
Brake light, adaptive 98

Brake system 132
 brake fluid 144
 brake fluid level 133
 brake pads indicator 21
 disc brakes 133
 hydraulic system indicator 19
 malfunctions 132
Break-in procedures 130
Bulbs and lamps 151

C

California Proposition 65 Warning 146
Can holder, refer to
 beverage holder 116
Capacities 171
Cargo area 38, 120
 capacity 170
 cover 120
 lamps 101
 partition net 122
Cargo floor, pull-out 124
Cargo loading 126
Cellular phone 116
 hands-free system 116
Center - high-mount - brake lamp 153
Center (high-mount) brake lamp 153

- Central locking system 30
 - button 35
- Changing a wheel 155
- CHECK button 77
- Check Control 77
- Check tire pressures 26
- Checking
 - engine oil level 142
- Child-safety locks 60
- Cigarette lighter
 - front 117
 - rear 118
 - socket 118
- Clean the windshield 69
- Climate control in the rear
 - passenger area 109
- Clock 82
 - refer also to the Owner's Manual for the Onboard Computer
- Cockpit 14
- Code 88
 - activating 88
 - deactivating 88
 - selecting 88
- Comfort seat 46
- Compartments 116
- Computer 80, 81, 85
 - refer also to the Owner's Manual for the Onboard Computer
 - remote control 89
- Configuring individual settings via Vehicle and Key Memory 61
- Consumption, fuel 87
- Convenience operation of windows and sliding/tilt sunroof 34
- Convenience starting
 - feature 63
- Coolant 143
 - temperature gauge 76
- Copyright notice 4
- Correct sitting posture 44
 - seat adjustment 44
- Cruise control 71
- Cruising range 80, 87
- Cup holder 116
- Curb weight 170
- D**
- Data link connector for On-board Diagnostics 147
- Date
 - calling up 82
 - changing 82
 - refer also to the Owner's Manual for the Onboard Computer
- Daytime driving lamp 99
- DBC Dynamic Brake Control 21, 92
- Deactivating the interior motion sensor 32, 40
- Deep water 131
- Defrosting the windows 104, 107
- Digital clock 82
 - refer also to the Owner's Manual for the Onboard Computer
- Dimensions 169
- Dipstick, engine oil 142
- Disc brakes 133
- Displacement 168
- Display lighting 100
- Displays 15, 16, 17, 18
- Disposal
 - used batteries 160
 - used oil 142
- Disposal of battery 160
- Distance from
 - destination 86
- Distance warning 90
- Divided rear backrest 120
- Door keys 30
- Doors
 - convenience operation 34
 - manual operation 34
 - remote control 32
 - unlocking and locking 34
- DOT Quality Grades 135
- Drink holder, refer to beverage holder 116
- Driving notes 132
- Driving through water 131
- Driving with spare wheel 159
- Driving your BMW X5 131
- DSC Dynamic Stability Control 21, 91
- Dynamic Brake Control DBC 21, 92
- Dynamic Stability Control DSC 21, 91
- E**
- Electric power windows 40
- Electrical malfunction
 - liftgate 36
 - sliding/tilt sunroof 43
 - tailgate 38
- Elements of operation 14
- Emergency operation
 - doors 34
 - liftgate 36
 - sliding/tilt sunroof 43
 - tailgate 38
- Energy control 74
- Engine
 - output 168
 - power rating 168
 - specifications 168

Everything from A to Z

Engine compartment essentials 140
Engine coolant 143
Engine oil 141, 142
 consumption 141
 grades 142
 level 20
 pressure 19
Estimated time of arrival 87
Exterior mirrors 53
Exterior rearview mirrors,
 automatic dimming
 feature 54

F

Failure of an electrical
 accessory 160
Filling the windshield washer
 reservoir 141
First-aid kit 24
Fittings, tow-starting and
 towing 164
Flashlight 115
Flat tire 98, 134, 155
Fog lamps 100
 bulb replacement 152
Folding rear backrest 120
Footbrake 133
Front area lighting 101
Front fog lamps 100
Front seat adjustment 44

Frost protection,
 radiator 143
Fuel 26
 capacity 171
 display 75
 gauge 75
 quality 26
 specifications 26
Fuel consumption 87
 average 87
Fuel filler door 24
 electrical malfunction 24
Fuses 160

G

Garage-door opener 112
Gasoline 26
General driving notes 132
Glasses compartment 117
Glove compartment 115
Gross vehicle weight 170
Ground clearance 131

H

Handbrake 64
Hands-free system 116
Hazard warning flashers 14
Hazard warning triangle 24
HDC Hill Descent
 Control 93

Head restraints 47
Headlamp flasher 68
Headlamp washer
 system 69, 141
Heated seats 51
Heated steering wheel 53
Heating and
 ventilation 102, 105
Heating while stopped 109
Heavy cargo 126
Height 169
Height adjustment
 seats 46
 steering wheel 52
High beams 22, 100
 bulb replacement 151
High-mount brake lamp 153
Hill Descent Control
 HDC 93
Holder for cans, refer to
 beverage holder 116
Hood 139
Hood release 139
Hydraulic Brake Assistant
 refer to DBC 21
Hydroplaning 132, 134

I

Ice warning 73
Identification, tires 137
Ignition key 30
Ignition lock 62
Imprint 4
Independent ventilation
 system 84, 111
 switching on and off 84
Indicator lamps 19
Inflation pressures,
 tires 134
 monitoring 97
INSPECTION 76
Instrument
 cluster 15, 16, 17, 18
Instrument lighting 100
Instrument
 panel 15, 16, 17, 18
Intensive cleaning
 system 69
Interior lamps 101
 remote control 32
Interior mirrors 54
Interior motion sensor 40
Interior rearview mirror,
 automatic dimming
 feature 54
Interlock 62
Intermittent wipe 68

- J**
Jack 155, 156, 158
Jump-starting 162
- K**
Key Memory 61
Keys 30
Keys with radio remote control 30
Kickdown mode 66
- L**
Lamps and bulbs 151
Lashing eyes 38, 126
LATCH – Lower Anchors and Tethers for CHildren – child-restraint system 60
Lead-free gasoline 26
Length 169
License plate lamps
 bulb replacement 154
Liftgate 36
 opening from the inside 36
 release following an electrical malfunction 36, 38
 remote control operation 32
Lighter 117
LIGHTS ON warning 99
Load-securing devices 126
- Louvers 102, 105
Low beams 99
 automatic 99
 bulb replacement 151
Low-fuel warning lamp 75
Lug bolts 158
Lug wrench 155
Luggage net 38
Luggage straps 38
Lumbar support 46
- M**
M+S radial tires 138
Maintenance 76, 145
Maintenance System 145
Malfunction displays 77
Manual operation
 doors 34
 fuel filler door 24
 liftgate 36
 sliding/tilt sunroof 43
 tailgate 38
Manual transmission 64
Master key 30
Maximum cooling 108
Mechanical seat 45
Memory 50
 driver's seat 50
 mirrors 50
 steering wheel 50
Messages concerning system malfunctions 77
- MID Multi-Information Display 81
 digital clock 82
Mirror defrosting 53
Mirror memory 50
Mirrors 53
Modifications, technical 9, 146
Monitoring inflation pressure, tires 97
Moonroof 42
Multifunction buttons, steering wheel 23
Multi-Information Display MID 81
 digital clock 82
- N**
Navigation system, refer to the separate Owner's Manual
- O**
OBD interface socket 147
Odometer 73
Oil
 additives 142
 consumption 142
 dipstick 142
 grades 142
 temperature gauge 75
- Oil change interval, refer to the Service and Warranty Information Booklet for US models or to the Warranty and Service Guide Booklet for Canadian models
Oil level 20
 indicator lamp 20
Oil pressure, indicator lamp 19
OILSERVICE 76
Onboard computer, refer to the separate Owner's Manual
Onboard Diagnostic system 147
Onboard tool kit 150
Opening and closing
 from the inside 35
 from the outside 34
 using the key 34
 using the remote control 31
Outlets, ventilation 102, 105
Outside temperature display 73
 in the computer 80

Everything from A to Z

P

- Park Distance Control
 - PDC 90
- Parking aid 90
- Parking brake 20, 64
- Parking lamps 99
- Particle filter 104, 110
- Passenger side mirror tilt
 - function 51
- PDC Park Distance Control 90
- Please fasten safety belts
 - warning lamp 20
- Poor driving conditions 131
- Power loss
 - sliding/tilt sunroof 43
- Power outlets
 - flashlight 124
 - other appliances 124
 - vacuum cleaner 124
- Power rating 168
- Power rear-seat backrests 48
- Power seat 46
- Power windows 40
 - safety switch 41
- Pull-out cargo floor 124

R

- Rain sensor 68
- RDC Tire Pressure Monitor 97
 - warning lamp 19, 21
- Rear backrests, folding down 120
- Rear lamps 153
- Rear passenger area climate control 109
- Rear seats, power 48
- Rear window defroster 103, 108
- Rear window wiper 70
 - blade replacement 150
- Rear-seat backrest, folding down 120
- Rear-seat backrests, power 48
- Rearview mirrors
 - exterior 53
 - interior 54
- Rechargeable flashlight 115
- Recirculated-air mode 103, 108
- Reclining seat 44
- Refueling 24, 181
- Releasing
 - hood 139
 - tailgate following an electrical malfunction 38

- Reminder signal – Memo 83
 - Remote control 31
 - computer 89
 - Removal aid for the spare wheel 156
 - Removing condensation from the windows 104, 107
 - Replacing
 - antifreeze, radiator 143
 - bulbs 151
 - fuses 160
 - windshield wiper blades 150
 - Reporting safety defects 10
 - Reservoir, washer system 141
 - Residual heat 106, 109
 - Reverse 65
 - Rims 137
 - Roller sun blinds 111
 - Roof load capacity 170
 - Roof-mounted luggage rack 127
- ## S
- Safe seating position 44
 - with airbags 44
 - with safety belts 44
 - Safety belts 49
 - height adjustment 49

- Safety defects, reporting 10
- Safety lock buttons 35
- Seat adjustment 44
- Seat belts 49
- Seat, electric power 46
- Seat heating 51
- Seat, mechanical 45
- Seat memory 50
- Seat, mirror and steering wheel memory 50
- Securing cargo 38, 126
- Selector lever, automatic transmission 66
- Self-leveling suspension 94, 131
 - inactive 94
 - warning lamp 21
- Service and Warranty Information Booklet for US models 145
- Service Engine Soon indicator lamp 21
- Service Interval Display 76, 145
- Set temperature 107
- Shiftlock 66
- Shoulder support 47
- Side airbags 55
- Side Impact Head Protection System 55

- Side lamps 99
 - bulb replacement 152
 - Sitting safely with
 - airbags 44
 - Sitting safely with safety belts 44
 - Ski bag 119
 - Sliding/tilt sunroof 42
 - closing following an electrical malfunction 43
 - convenience operation 34
 - power loss 43
 - remote control 32
 - Snow chains 138
 - Socket
 - power supplies 118
 - vacuum cleaner 118
 - Spare key 30
 - Spare tire 156
 - Spare wheel 156
 - removal aid 156
 - Spare wheel, driving 159
 - Speaker 116
 - Special features of winter tires 138
 - Special wash program 69
 - Speed 88
 - Speed control 71
 - Speed limit 85, 86
 - Speedometer 15, 17, 18
 - Sports seat 45
 - Standing lamps 100
 - Starting assistance 163
 - Starting problems 63, 163
 - Starting the engine 62, 63
 - Steering lock 62
 - Steering wheel
 - adjustment 52
 - adjustment, automatic 52
 - heating 53
 - lock 62
 - memory 50
 - Steering wheel with multifunction buttons 23
 - Steptronic 65
 - Stopwatch 83
 - Storage compartments 116
 - in the cargo area 123
 - Summer tires 137
 - Sunroof 42
 - Sunshades 111
 - Switching off the engine 63
 - Switch-on times
 - input 84
 - Symbols 8
 - Synthetic oils 142
 - System malfunction
 - indicators 77
- ## T
- Tachometer 74
 - Tail lamps 153
 - bulb replacement 153
 - Tailgate 37
 - opening from the outside 36
 - release following an electrical malfunction 38
 - remote control operation 32
 - Tank capacity 171
 - Technical modifications 9, 146
 - Telephone preparation 116
 - Temperature display, outside
 - temperature 73, 80
 - Temperature gauge 75, 76
 - Temperature
 - layering 104, 109
 - Temperature setting 107
 - Thigh support
 - adjustment 45
 - Third brake lamp 153
 - Tilt alarm 32
 - Tilt alarm sensor 40
 - Tilt function, passenger side mirror 51
- ## Time
- calling up 82
 - changing 82
 - of arrival, estimated 87
- ## Timer
- refer to Stopwatch
 - refer also to the Owner's Manual for the Onboard Computer
- ## Tire
- 134
 - damage 134
 - pressure monitoring 97
 - replacement 135
 - tread 134
 - condition 134
 - inflation
 - pressures 26, 134
 - monitoring 97
 - table 27
 - Pressure Monitor RDC 97
 - warning lamp 19, 21
 - Quality Grading 136
- ## Tools
- 150
- ## Torque
- 168
- ## Tow fittings
- 164
- ## Towing the vehicle
- 164
- ## Tow-starting
- 164
- ## Track width
- 169

Everything from A to Z

Traction Control System,
refer to DSC 91
Transmission 64, 65
Transporting children
safely 58
Tread depth, tires 134
Trip odometer 73
Turn signal indicator 68
bulb replacement 152
Turning circle 169
Two-axle self-leveling
suspension 94
display 95
lowering 96
raising 95

U

Uniform Tire Quality
Grading 136
Universal Transmitter 112
Used batteries,
disposal 160
Used oil, disposal 142

V

Vacuum cleaner
power outlet 124
socket 118

Valve caps 159
Variable Ride Height 94
Vehicle battery 160
Vehicle jack 155
Vehicle keys 30
Vehicle Memory 61
Vehicle vacuum cleaner
power outlet 124
socket 118
Ventilation 102, 104, 109
draft-free 104, 109
in the rear 104, 109
while parked 111
Viscosity 142
Voice entry 23

W

Warm feet – cool head 104
Warning lamps 19
Warning messages 77
Warning triangle 24
Warranty and Service Guide
Booklet for Canadian
models 145
Washer fluid 141
Washer reservoir, filling 141
Washer/wiper system 68
Weights 170

Wheel and tire
combinations 137
Wheel, changing 155
Wheelbase 169
Wheels and tires 137
Width 169
Windows 40
convenience operation 34
remote control 32
Windshield
intensive cleaning
program 68
special wash program 68
Windshield washer
filling reservoir 141
Windshield wiper 68
blade replacement 150
Winter tires 138
Wiper blade
replacement 150
Wipers 68
Work in the engine
compartment 139

X

Xenon lamps 152

Refueling



So that you will have important specifications available when you stop to refuel, we recommend that you supplement this table with data which apply to your vehicle.
Consult the index for individual specifications.

Fuel

Designation	
-------------	--

Please enter your preferred fuel here.

Engine oil

Quality	
---------	--

The oil volume between the two marks on the oil dipstick corresponds to approx. 1.1 US quarts/1 liter.

Tire inflation pressures

	Summer		Winter	
	Front	Rear	Front	Rear
4 persons				
5 persons or 4 plus luggage				

More about BMW

bmwusa.com



The Ultimate
Driving Machine

